

# From 5-axis to edge. Scalable performance.

**HE HOMAG**

## **Our CNC Processing Centers**

CENTATEQ P-310

CENTATEQ E-310

## **YOUR SOLUTION**

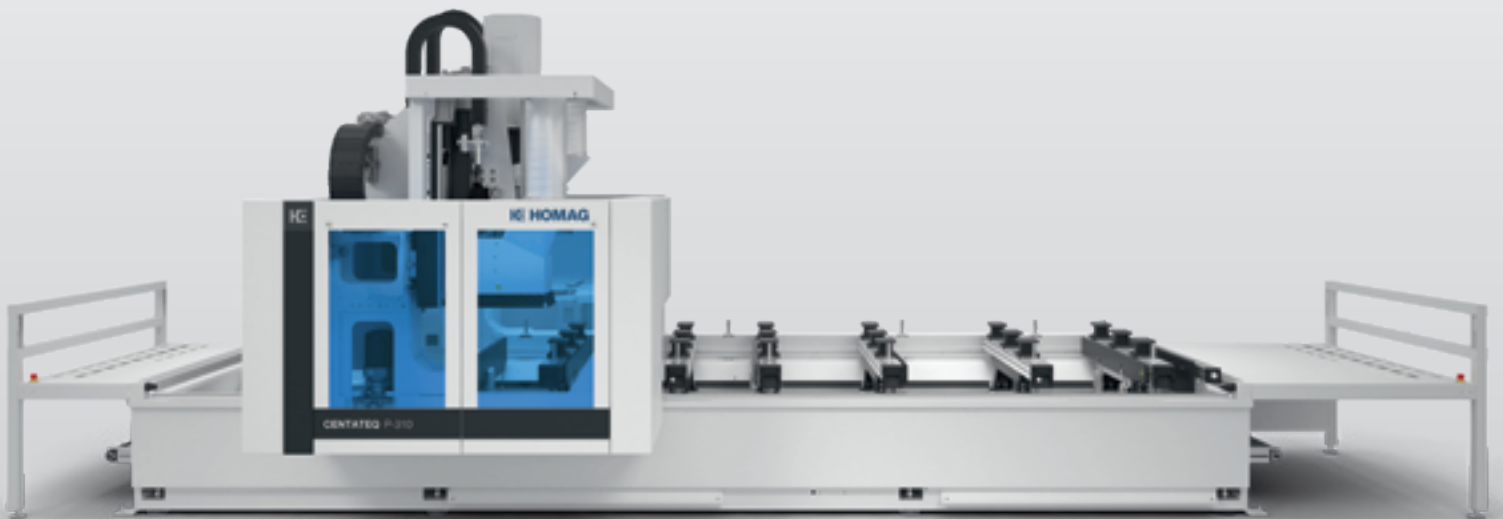





## Be on the safe side with HOMAG

You should not experiment with investment in a new machine or plant. Rely on the competence, experience and reliability of a strong partner – rely on HOMAG.

### YOUR SOLUTION

### CONTENTS

- 04 Operating concept
- 06 Quality and innovation
- 08 Processing examples
- 10 Drilling technology
- 12 Main spindle technology
- 14 Changer systems
- 16 Aggregates
- 18 Edge banding technology
- 24 Console table
- 28 Automatic A-table setup
- 30 Software
- 34 powerTouch2
- 36 tapio
- 38 Life Cycle Services
- 40 Configurations
- 42 Technical Data

## Operation made easy

### WORKING ON A CNC MACHINE HAS NEVER BEEN SO EASY AND CONVENIENT:

All of the essential functions are directly in view and mounted directly on the machine. Thanks to the large window everything is always in view. Access to the table is free, no disturbing fences are required to the left and right. Fully implemented bumpers combine productivity, security and access to the machine.

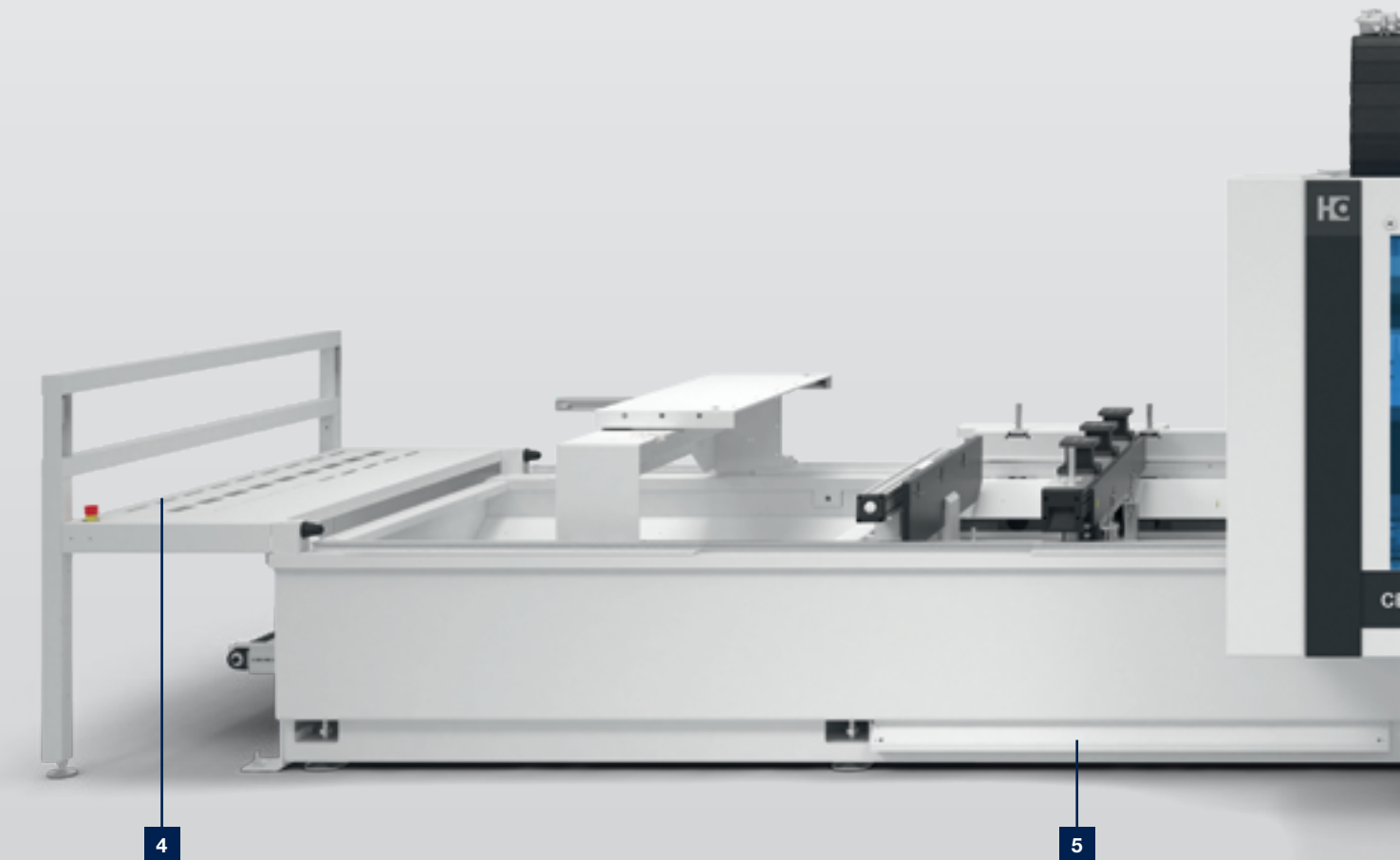

**Switch bar instead of foot switch** – no searching and moving the foot switch – stops, output stroke rails and vacuum clamping can be activated easily.



**Button for program start** directly on the left and right stop profile of the machine table. The clamping status is immediately in view thanks to the multi-colored light display.



**Easy access** – drill changes, service, refilling adhesive and edge changes can be carried out easily from the front side of the machine.

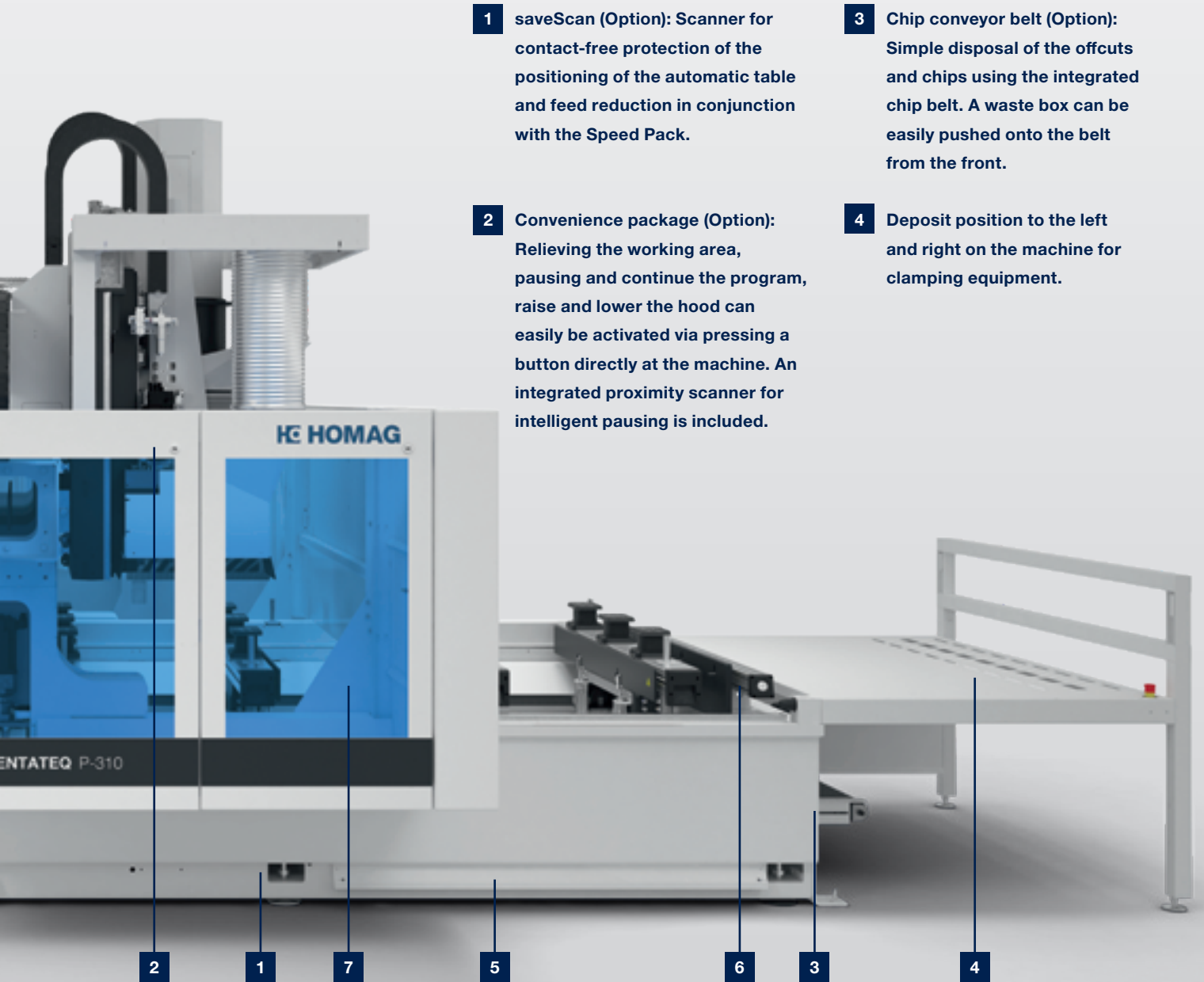

**1 saveScan (Option):** Scanner for contact-free protection of the positioning of the automatic table and feed reduction in conjunction with the Speed Pack.

**2 Convenience package (Option):** Relieving the working area, pausing and continue the program, raise and lower the hood can easily be activated via pressing a button directly at the machine. An integrated proximity scanner for intelligent pausing is included.

**3 Chip conveyor belt (Option):** Simple disposal of the offcuts and chips using the integrated chip belt. A waste box can be easily pushed onto the belt from the front.

**4 Deposit position to the left and right on the machine for clamping equipment.**



**Smart support** for support and maintenance using the service pad and display of machine status on smart devices.



**Second operating terminal (option)** for optimum shuttle operation without unnecessary walking – ideal for machines with a large work field. Program selection and assignment of the machine is possible on both sides.

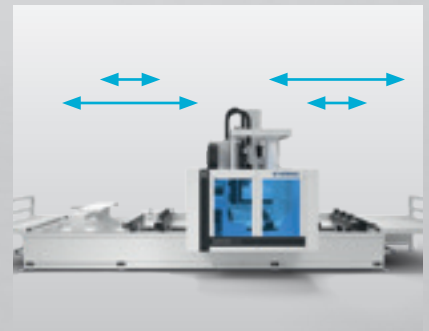

**Dynamic alternating operation** without fixed field subdivision. This means that even in the case of long parts on one side of the machine a short part can still be placed on the other side.

## Quality and innovation down to the last detail

Innovative solutions for every task. Superior technology from the start. Every customer benefits from HOMAG system competence. The sum of decades of experience in machine and plant engineering goes into our machining centers.

Identical system components, uniform control technology and ergonomic operation ensure more productivity. The latest technologies for the variable high-quality workpiece shapes.



**1** Powerful 4- and 5-axis routing spindles

**2** Tool changer traveling with the spindle for tool change during drilling

**3** Tool change systems traveling for high capacity and fast access

**4** Console table with high-precision linear guides and robust insertion aids

**5** powerEdge gluing unit with pneumatic outward stroke (CENTATEQ E-310)

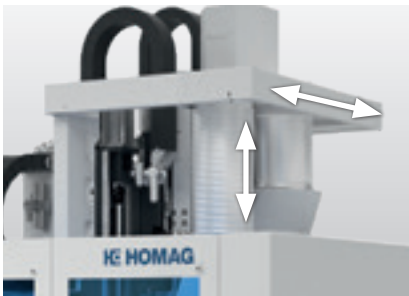

**Effective suction** at low connected load thanks to optimized detection and removal of chips. The hood is stepless with adjustable by motor.



- 1** Automatic central lubrication of all main axes
- 2** Covered linear guide with closed guide carriage
- 3** Rack and pinion drive systems in X and Y
- 4** Closed energy chains to protect cables and hoses

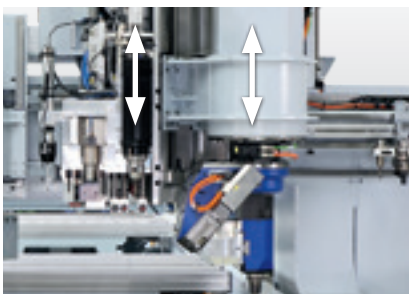

**Two separate Z axes** for drilling head and working spindle permit rapid alternating drilling head and working spindle application. A drive unit moves only one unit over the full axis length.

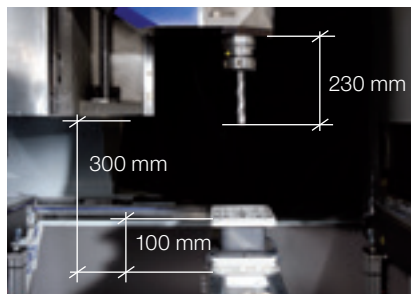

**Processing height** 300 mm from the upper edge of the console, even with the use of units or long tools.



**Central switch cabinet** with height-adjustable powerTouch operating terminal, UPS to protect against data loss, Backup Manager for data backup and network connection. Light on the switch cabinet for status display.

## As individual as your needs

When you decide on a HOMAG machine, you receive a powerful processing center for a wide range of tasks. Each machine is a complete system that guarantees maximum performance and efficiency in individual production tasks.

### DRILLING & ROUTING

---



High-speed drilling technology with groove saw

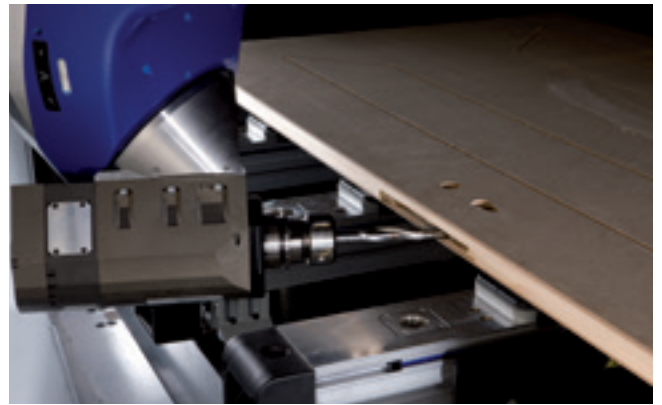

Lock case routing



Trim a chamfer on a table plate



Routing a staircase handrail



Angular cutting of a glass rabbet corner



Holes for piling at a tight angle



## SAWING & CONNECTING



Precise and tear-free miter cuts



Routing a burr connection for jamb/rail designs



Separating cuts up to 110 mm in height

## EDGE BANDING



easyEdge gluing unit for rational gluing on shaped parts

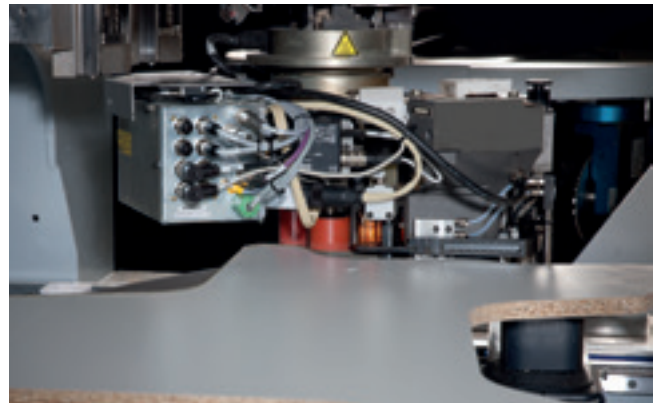

360° edge gluing with the powerEdge edge banding unit



Perfect edge finish through traced combination flush routing/  
scraping unit

# HOMAG drilling technology: The best of the best

High-speed drilling technology, patented clamping of the spindle and quick-change system for tools. Precise drilling, fast cycles, maintenance-free and durable construction.

Additional optional attachments expand the machine's range of applications.

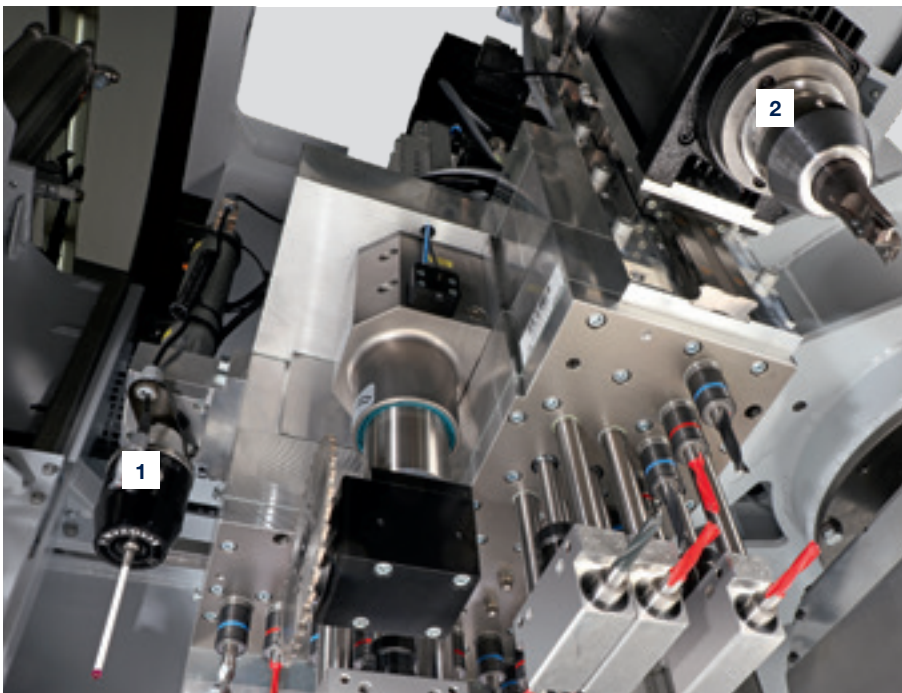

**1** Measuring device to identify the relevant actual dimensions in X, Y, Z with automatic offset correction in the processing program.

**2** Additional routing spindle

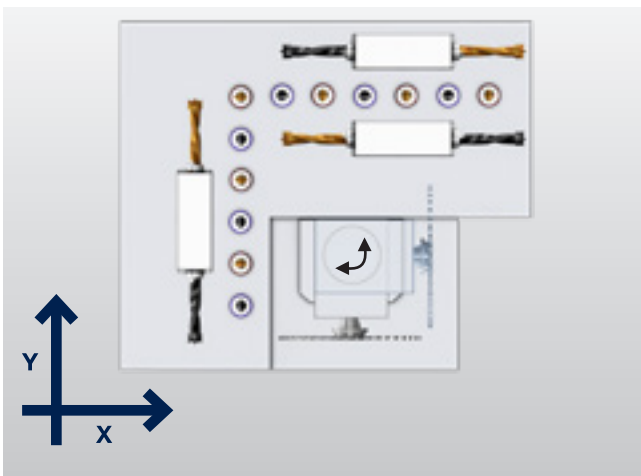

## Drilling gear V12/H4X2Y

- 18 drilling spindles [High-Speed 7500]
- 12 vertical drilling spindles
- 4 horizontal drilling spindles in X
- 2 horizontal drilling spindles in Y
- Groove saw Ø 125 mm (0°/90°)

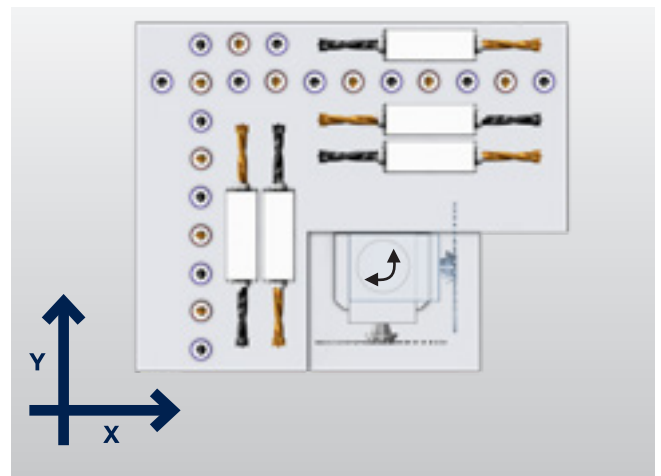

## Drilling gear V21/H6X4Y

- 31 drilling spindles [High-Speed 7500]
- 21 vertical drilling spindles
- 6 horizontal drilling spindles in X
- 4 horizontal drilling spindles in Y
- Groove saw Ø 125 mm (0°/90°)

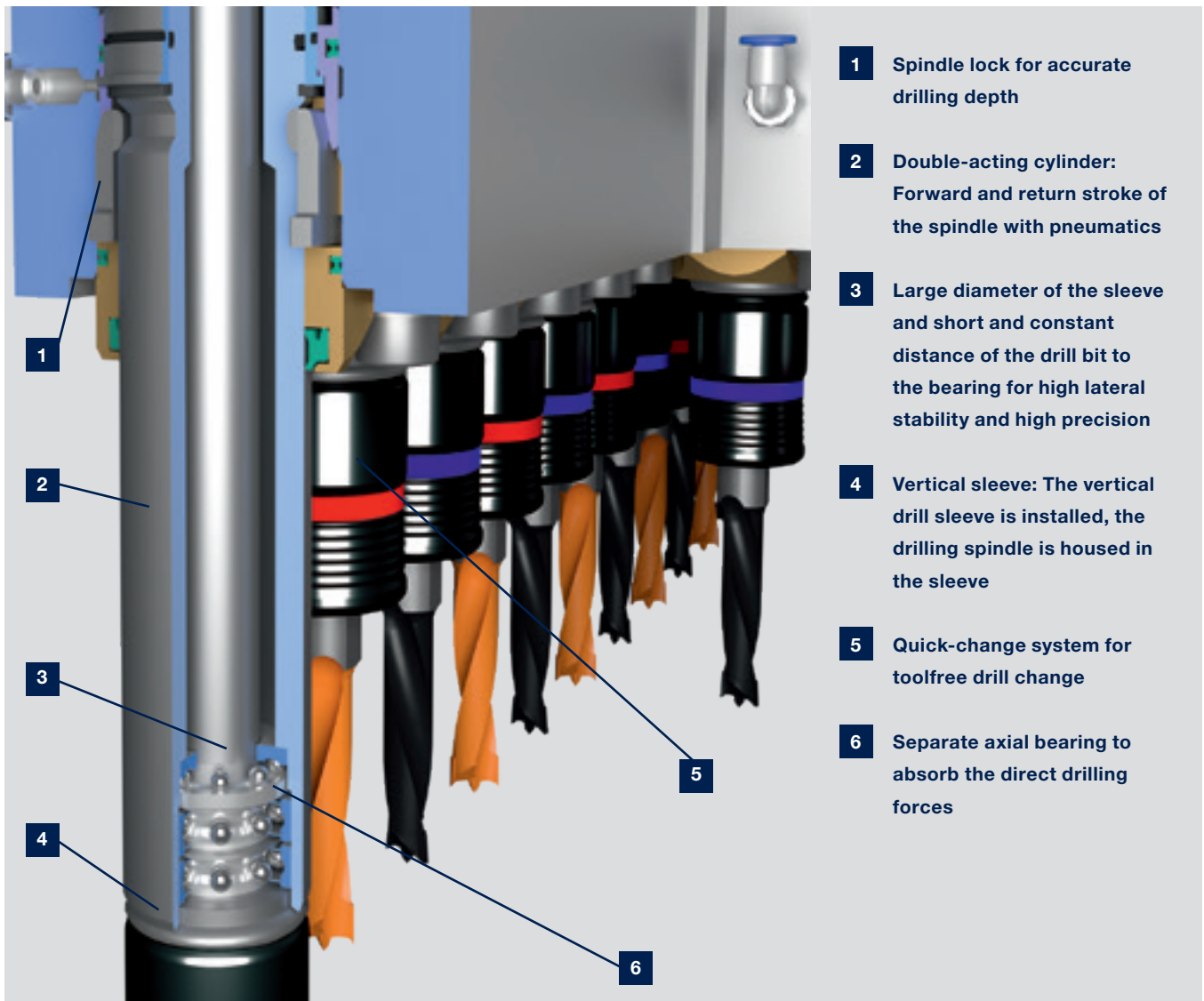

**Patented quick-change system** for a drill change without tools to reduce setup times.

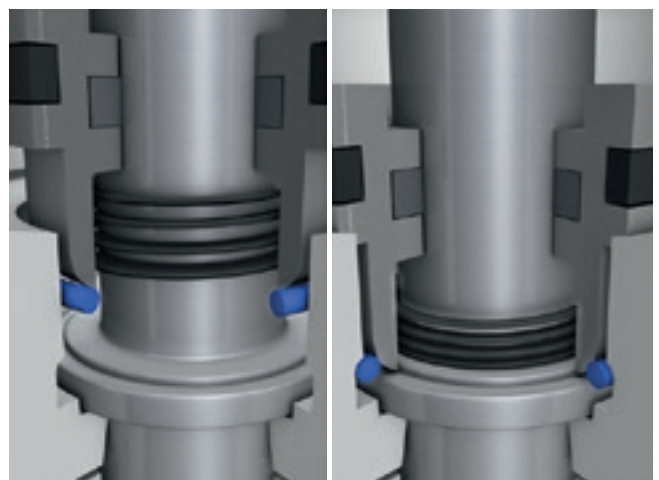

**Automatic spindle lock** – patented system for a drilling depth that is always accurate for numerous different materials. With speeds from 1500–7500 rpm for high feed speeds or short drill cycles.

## Main spindle technology

We are setting standards with our main spindle technology, increasing the performance and flexibility of our machines. Our highlights are the vibration sensors, which avoid damage to the routing spindles, and the 5-axis technology. Select the spindle suitable for your current and future product range.

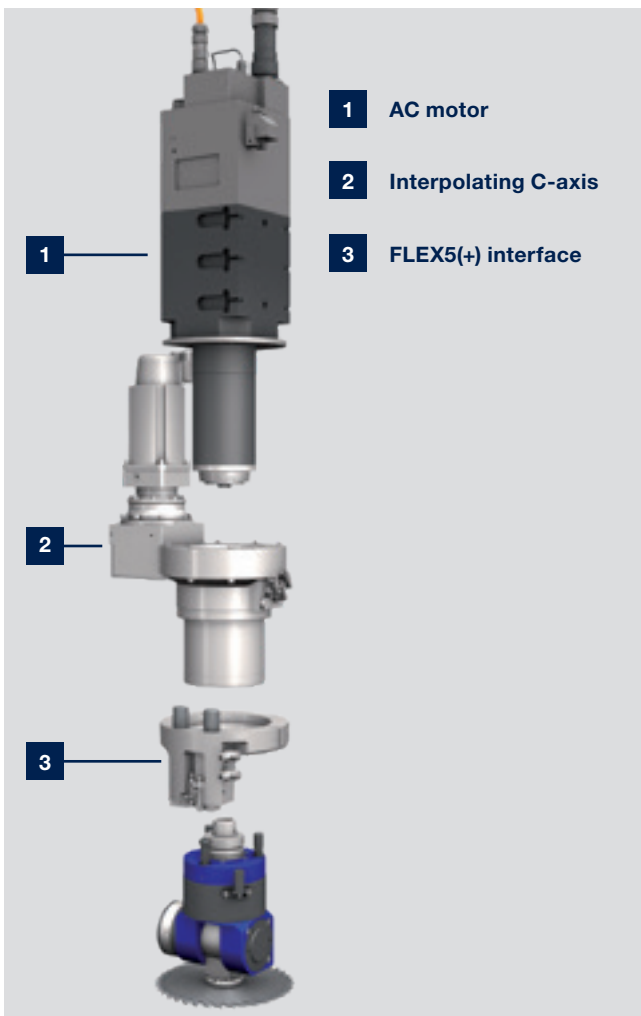

**4-axis routing spindle** with units interfaces, which open up almost unlimited production opportunities. With patented technologies the range of tasks can be expanded at any time.

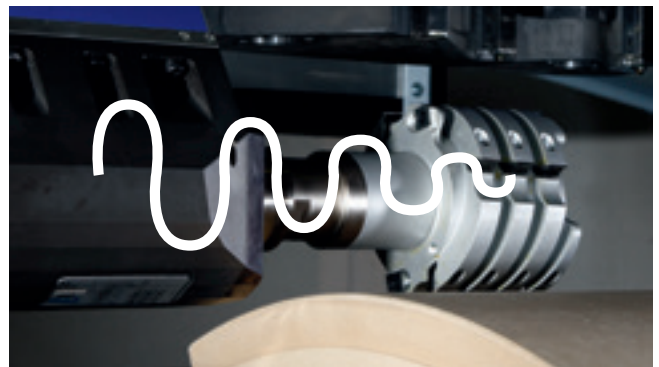

**Liquid cooling and spindle sensor** – liquid-cooled routing spindles with hybrid storage offer a long service life. An additional vibration sensor detects tool unbalances and protects the spindle against overloading, due to high feed speeds for example.



**Sawing, routing, drilling at any angle – FLEX5+ unit** with automatic angle adjustment and automatic tool change. A unique unit for 4-axis spindles, which covers over 90% of 5-axis applications.



**5-axis routing spindle DRIVE5C/+** with 10 kW of power (optionally 12 or 15 kW) and a controlled spindle speed from up to 24,000 rpm for a high torque even at low engine speeds.

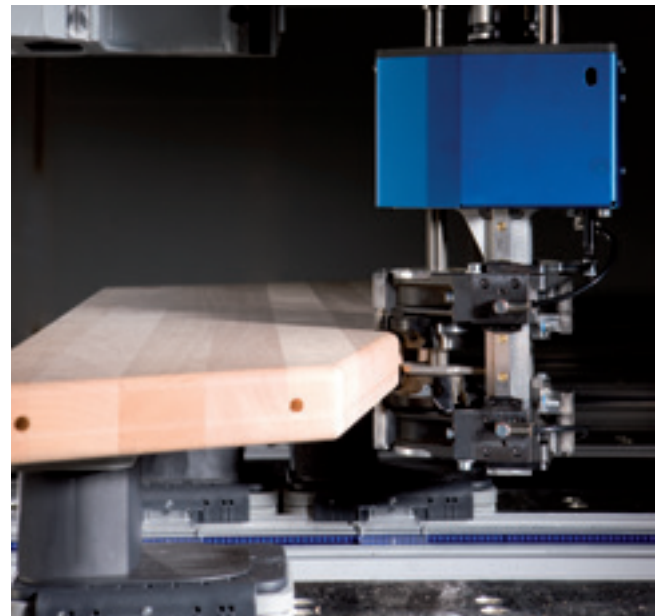

**Pneumatic interface** – the patented interface with 3-way support on all C-axes and 5-axis heads enables the use of traced units, e.g. for precise rounding off at the top and bottom no matter the thickness tolerances.

## Changer systems: Just be flexible

Everything is in good hands and quick to access. Tool changers are the basis for flexible utilization of tools and units, and also for large saw blades or heavy units.



**1** Changers traveling with the spindle for tool change during drilling or edge banding.

**2** Changer traveling in X direction for fast access and large capacities.

**3** Changer on the side of the machine bed with integrated tool transfer station. Additional capacity and convenient exchange of tools from the front.

## Systems for all requirements

There is nothing left to be desired: More than enough capacity with up to 50 (32 + 10 + 8) storage spaces and fast processing by systems with short change times.

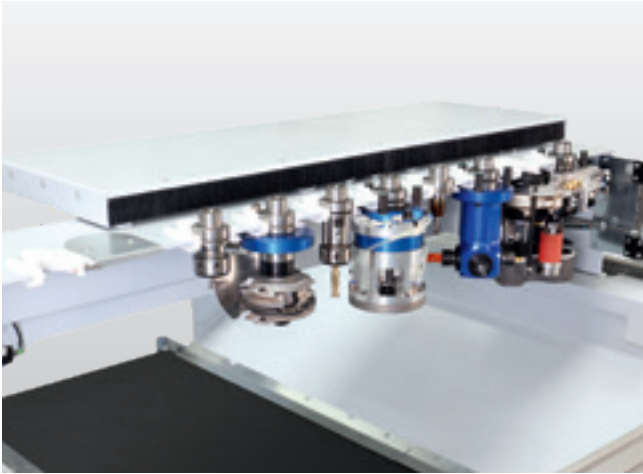

**8-space linear changer** with tool transfer station, mounted on the side. As an option, the pick-up station for the easyEdge unit can also be integrated.



**10-space tool changer** traveling with spindle. Tool change during drilling or edge banding. For tools and units with a diameter of up to 180 mm.

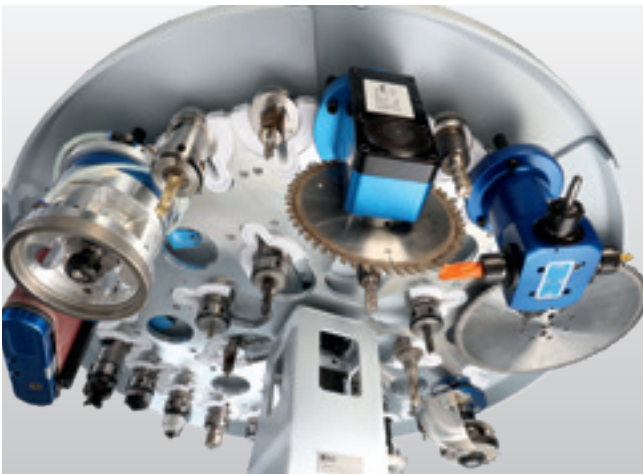

**32-space tool changer** – arrangement of the tools in an inner and an outer ring. For tools and units with a diameter of up to 200 mm and saw blade up to 350 mm in diameter (in the outer ring).



**14-space tool changer** for tools and units with a diameter of up to 200 mm and saw blade up to 350 mm in diameter.

## Units: Excellent processing quality and new standards for speed

The HOMAG units provide numerous innovative technologies. They can be combined and precisely coordinated to your specific application situation. Even special tasks are worked out safely and efficiently.



Corner notching unit



Underfloor routing unit



Boring/routing unit



Boring/routing unit



FLEX5 drilling/sawing/routing unit



Routing unit



Lock-plate routing unit



Belt sanding unit



Eccentric sanding unit



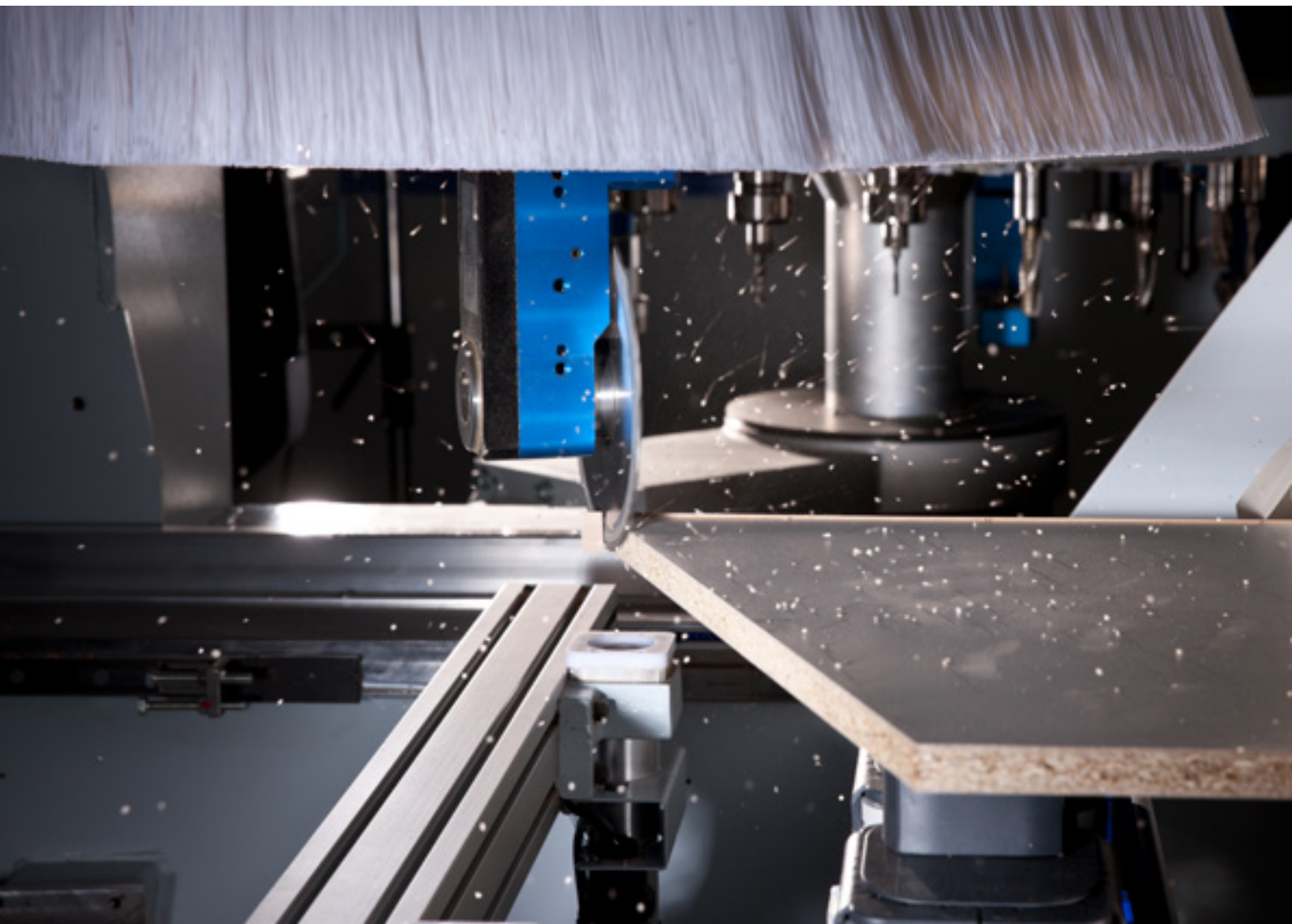
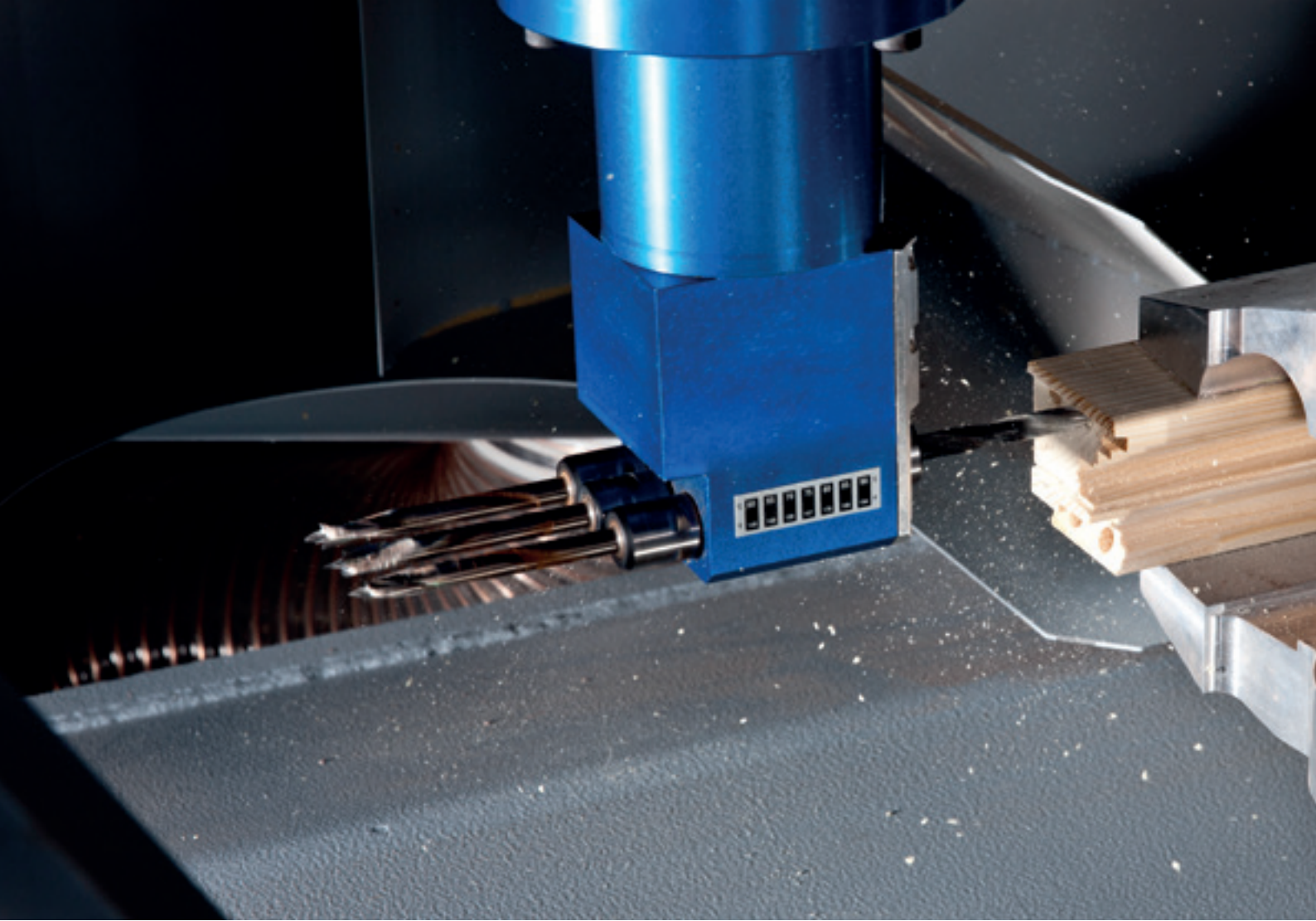

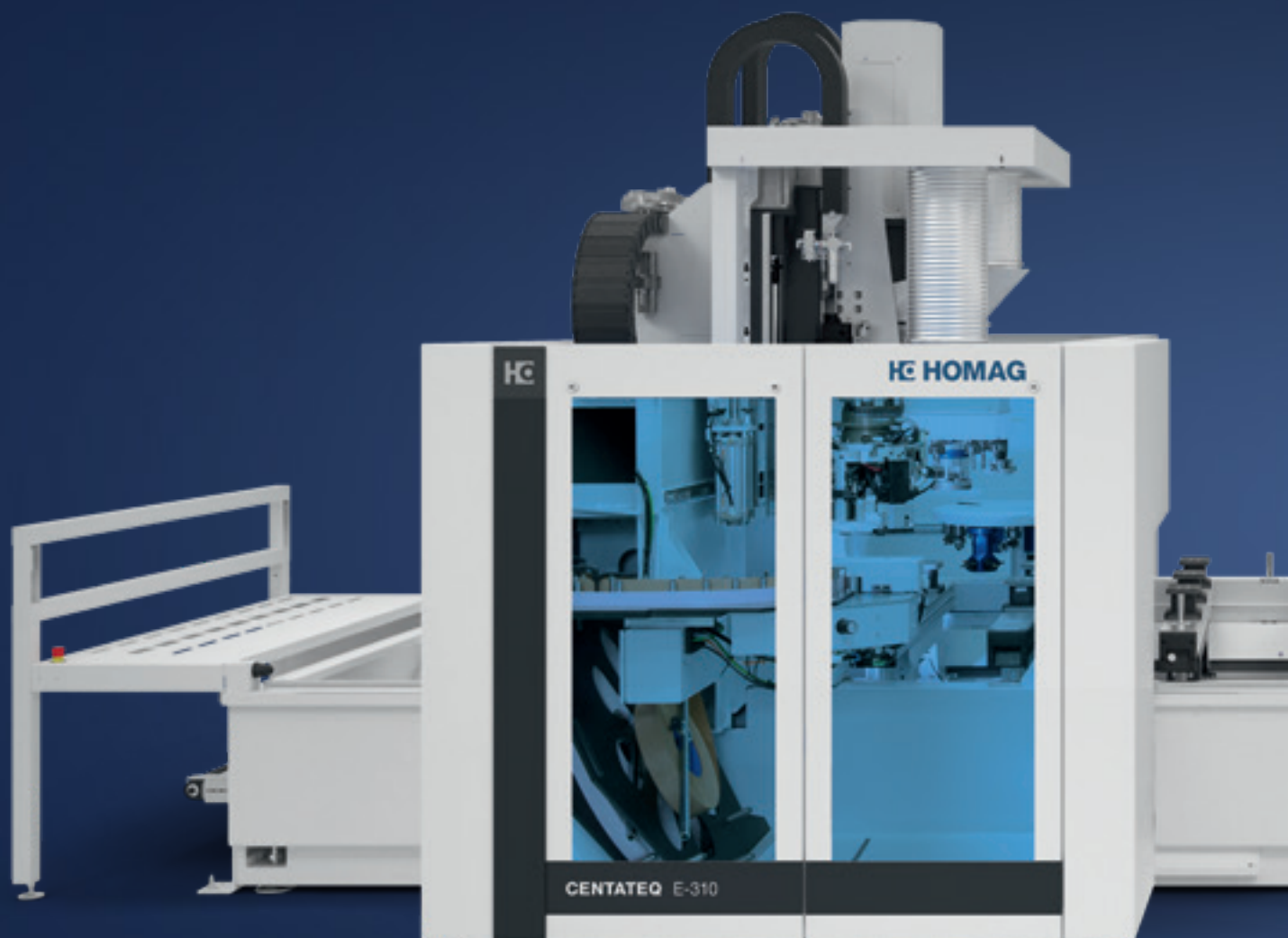

# CENTATEQ E-310

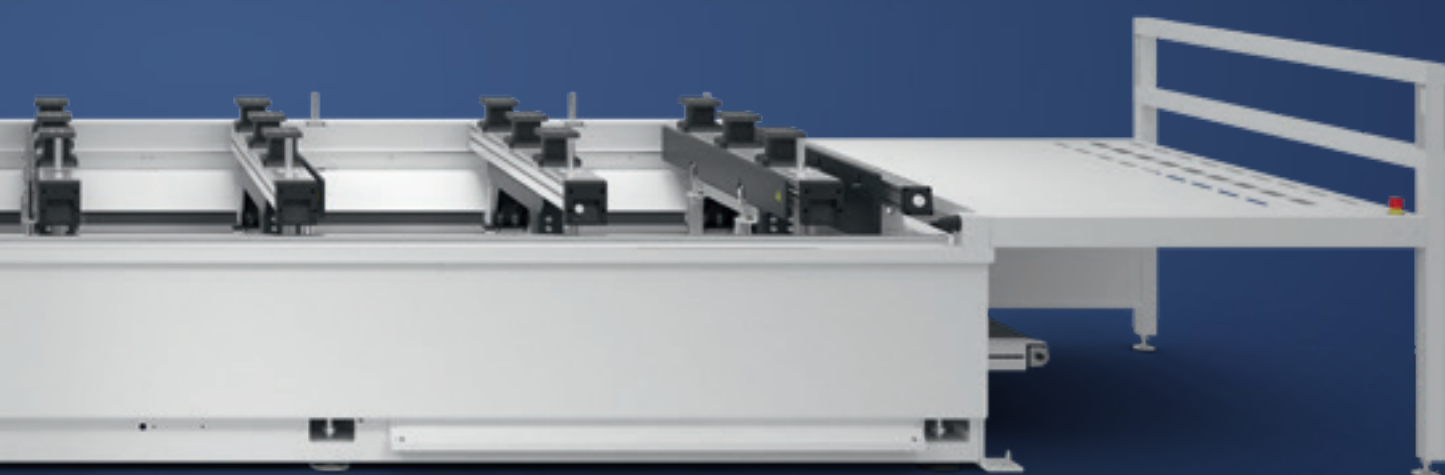

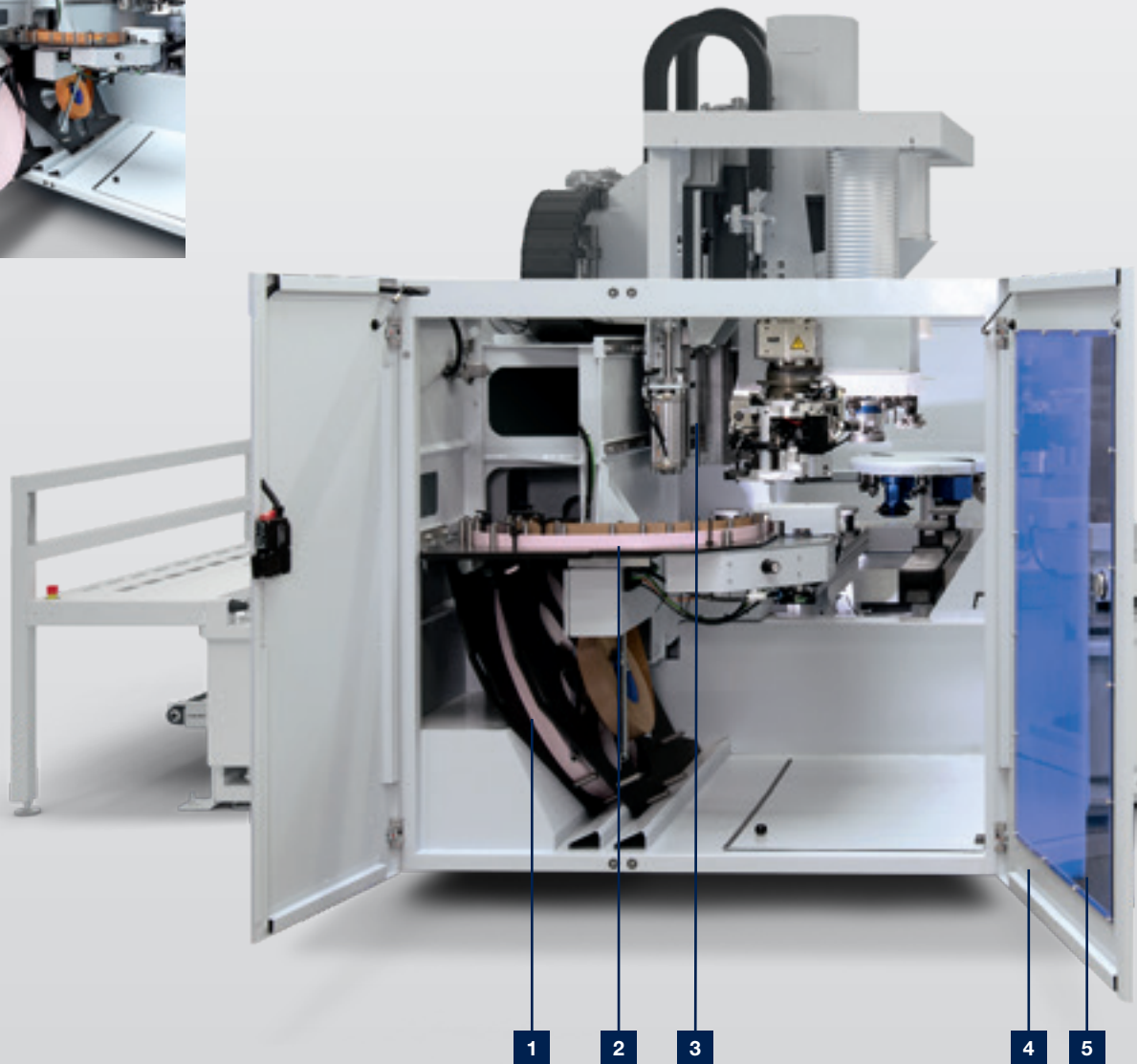

## Edge banding with HOMAG: Top edge quality with easy operation

Compact and powerful: The CENTATEQ E-310 is the ideal solution for smaller companies and suppliers when it comes to shaped edge banding. The CENTATEQ E-310 achieves a high level of performance in a small space thanks to the

compact arrangement of the units and the free choice of configuration, with tool change spindles, drilling gears and tool changers.

**1** External preparation of the edges with exchangeable roll plates

**2** Quick and convenient insertion and exchange of edge materials through installation of the edge magazine on the front side of the machine

**3** Easy refilling of hot-melt glue, simple inspection and service of the gluing station

**4** Optimal access to the processing units through a large access door

**5** Optimum view into the processing through large viewing window

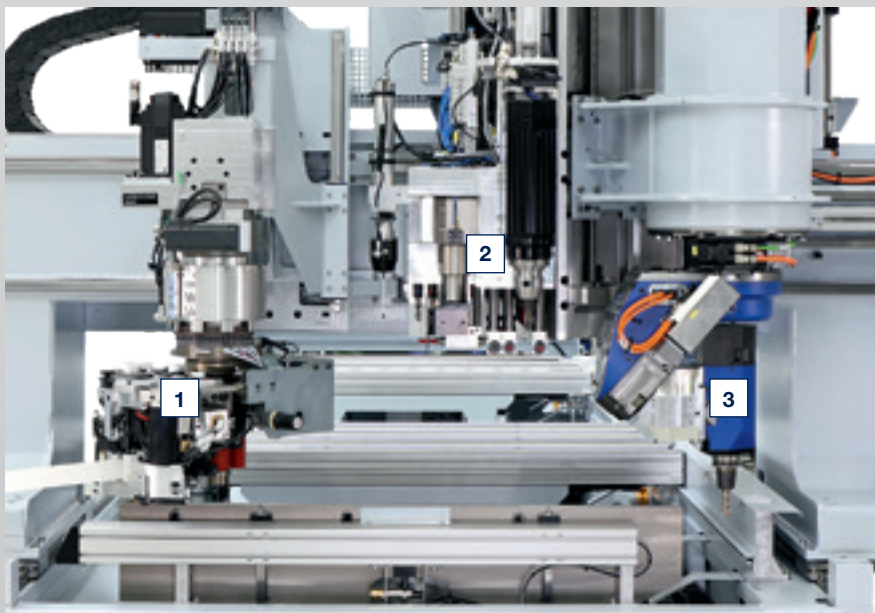
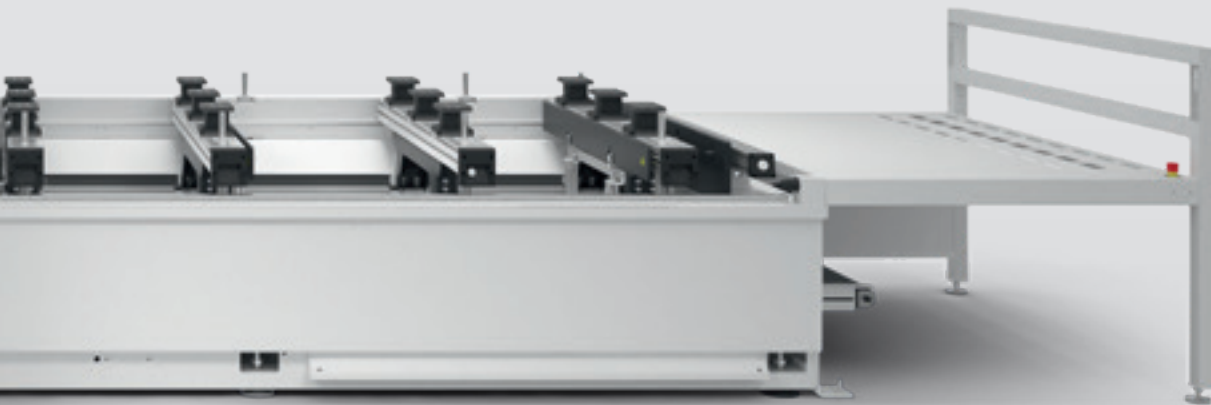

**1** powerEdge gluing unit with pneumatic outward stroke

**2** High Speed drilling gear with attachments (optional)

**3** Powerful 4- and 5-axis routing spindles

## Perfection for corners and edges

The CENTATEQ E-310 is a real all-rounder. Formatting, profiling and drilling is supplemented with shaped edge banding, with perfect joints and edge finish.



**powerEdge edge banding unit** with proven technology from industrial multishift application. For perfect radii and 360° butt joint gluing.

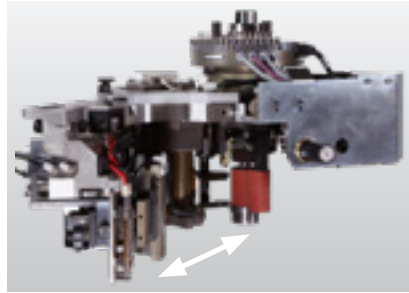

**Quick service function** for fast and efficient maintenance and cleaning thanks to straightforward opening.



**easyEdge edge banding unit** is the universal solution for edging small quantities.



**Additional application unit** for quick changing for different glue types. With optional non-stick coating for manual filling with PU.



**Sawing and snipping unit** with saw blade in the center of the C axis. Snipping cuts during edge banding are therefore performed with high precision.

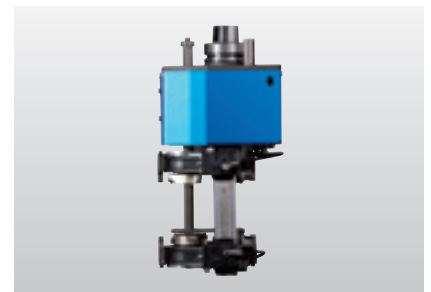

**Combination unit** for flush milling of the edge overhang and the scraper postprocessing in order to remove blade strokes and other unevenness on the edge profile.



**Combination unit**, snipping/corner rounding. For the traced cutting to length of edge overhangs and precise corner rounding of edges.



**Flush trimming unit with separating agent** reduces the glue residue on the workpiece and often makes the glue joint scraper unnecessary.



**Trimming unit**, horizontally traced for flush trimming of edge overhangs, e.g. on the postforming profile of a kitchen worktop.

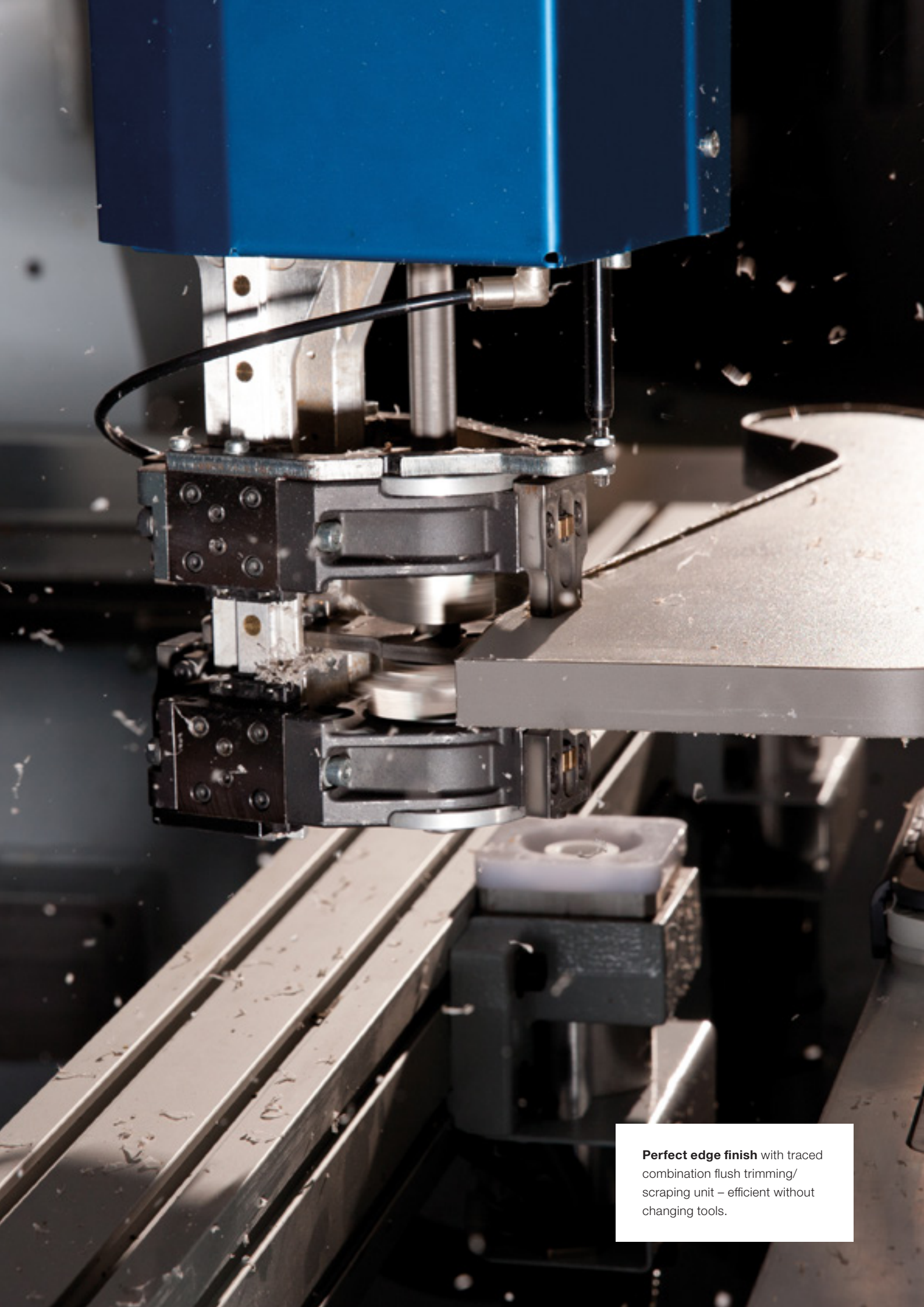

**Perfect edge finish** with traced combination flush trimming/scrapping unit – efficient without changing tools.

## Flexible and fast: The K-table

### THE CLASSIC, DUAL-CIRCUIT VACUUM SYSTEM.

The vacuum clamps are infinitely positionable and offer a free space for the use of tools as well as for the falling offcuts. The K-table is the ideal solution when flexibility, secure clamping of very different parts and fast exchange of the clamping

systems are required.

The rapid, precise and especially easy positioning of the suction unit is enabled by the LED or laser positioning aid.



**Measuring tape** for positioning the suction units.

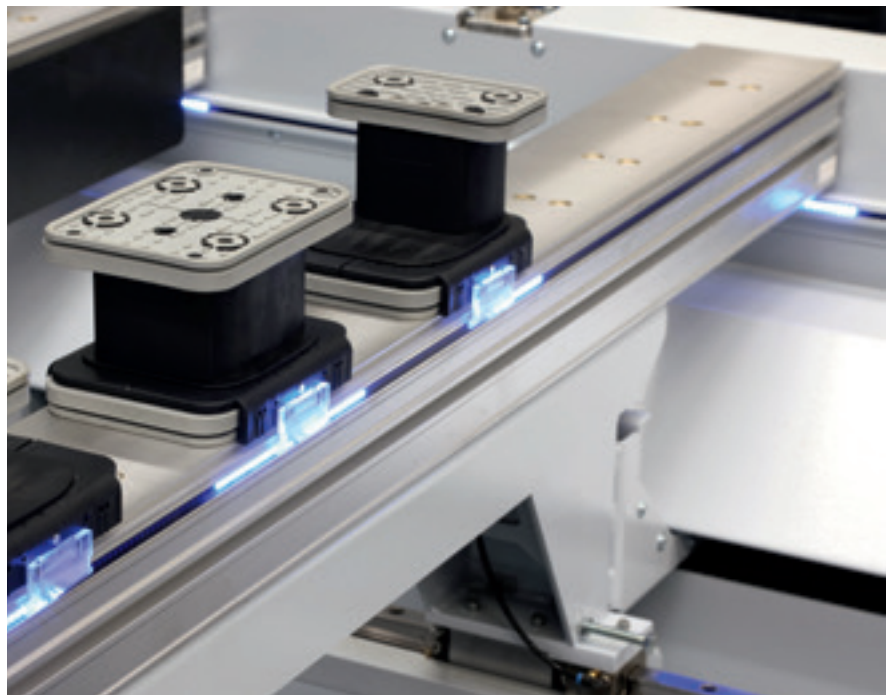

**LED system** – arguably the fastest and safest positioning system for consoles and clamping elements.



**LASER positioning aid** – vacuum suction units are indicated by a laser cross-hair. The workpiece contour can be “moved” as a positioning aid for free-formed workpieces.

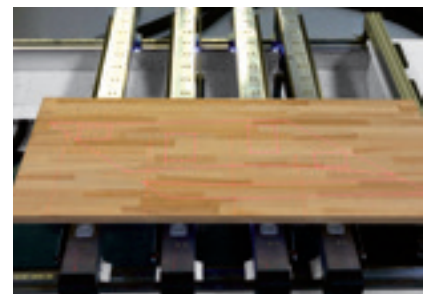

**Laser projection** of the clamping equipment and the workpiece contour for optimal utilization and simple positioning of unprocessed parts that cannot be aligned on the stops.



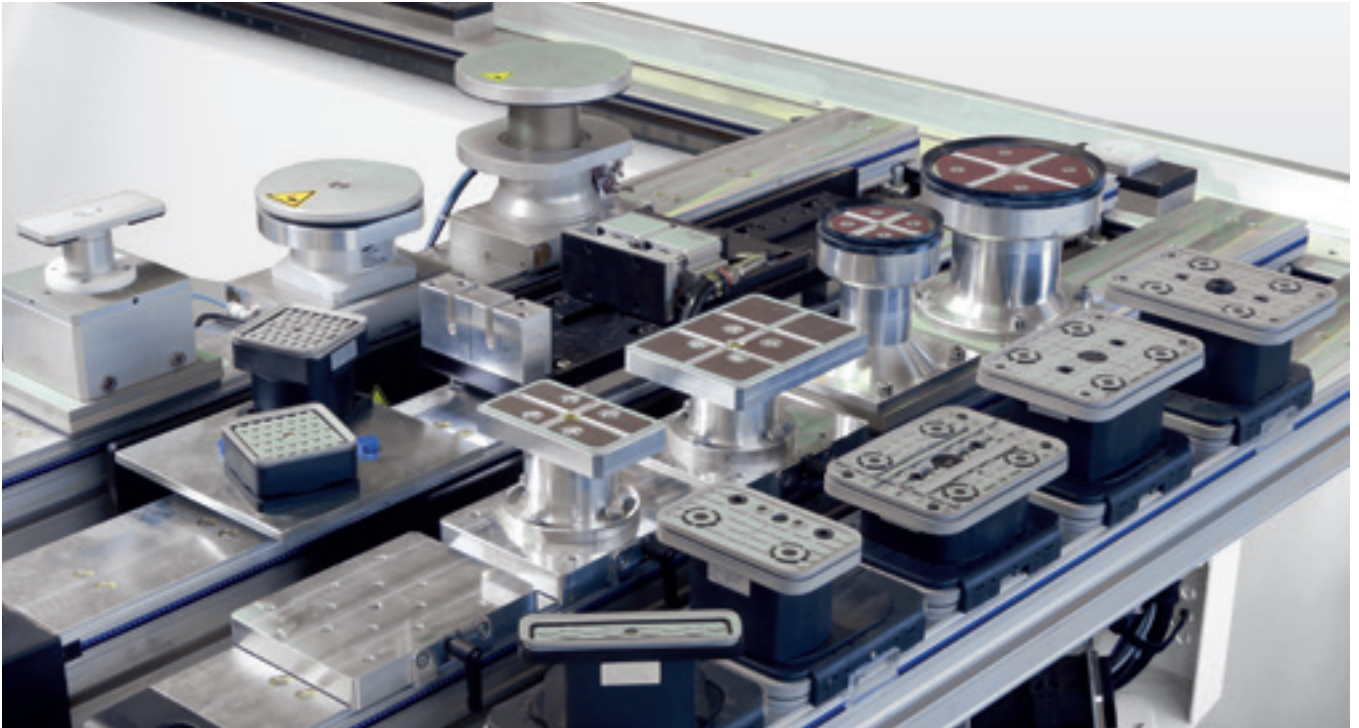

**Clamping unit** ensures safe and quick clamping of jambs and scantling.



**powerClamp** manual clamping device for straight and curved parts. Ideal for all curved, narrow and frame parts.

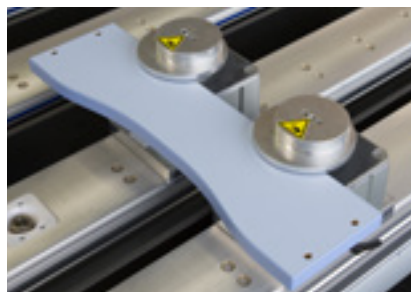

**Multi-clamp** for dual-circuit vacuum system. Vacuum-actuated clamping element for clamping strips and elements.



**Matrix adapter plate** also offers secure fixing for filigree workpieces. Shaped parts in the nesting process can also be "tailored" on a console table in an optimized way with the matrix adapter plate.

## Accurate and safe with the console table

Thanks to the patented system of solenoid valves, vacuum suction units and other clamping equipment can be used in any number and in any location on the consoles. Application-optimized stops and insertion aids ensure precise placement and positioning of the components.

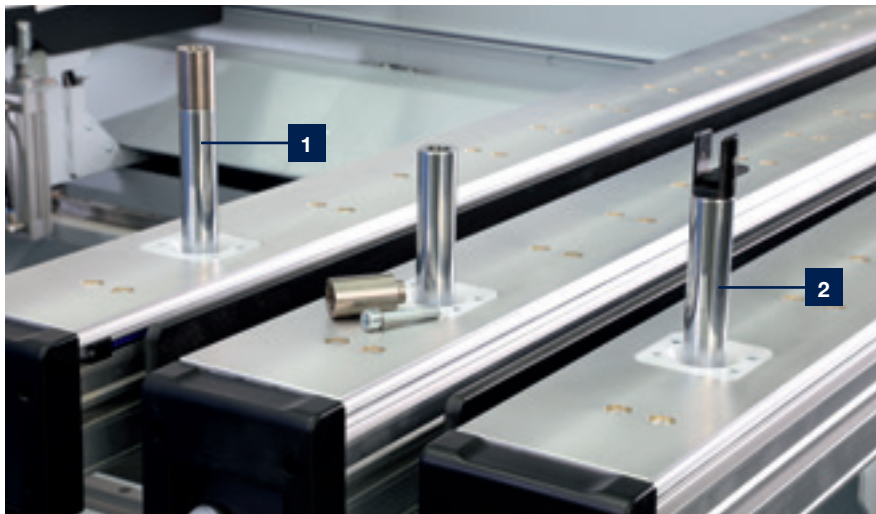

- 1** Stop pin
- 2** Stop pin for covering layer overhang



**Electronic cylinder surveillance**  
Improved safety by electronic surveillance of all stop cylinders



**Stop pin for covering layer overhang**  
with end position monitoring to protect tools, units and machine operating personnel.

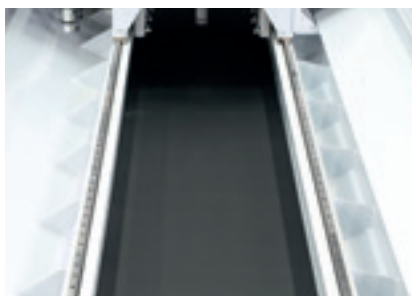

**Chip conveyor** for easy disposal of the offcuts and chips.

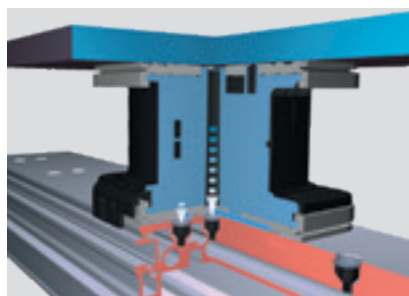

**Dual-circuit vacuum system** – exclusive vacuum clamping technique with double sealing flange for infinitely variable movement of the clamps along the console. The first clamping circuit fixes the clamp on the console and prevents unintentional moving, the second then keeps the material stably in position.



»PURE STOP« side stop made of anodized aluminum is guided on linear guides. Precise and solid stop for positioning strips and rounded-off components.

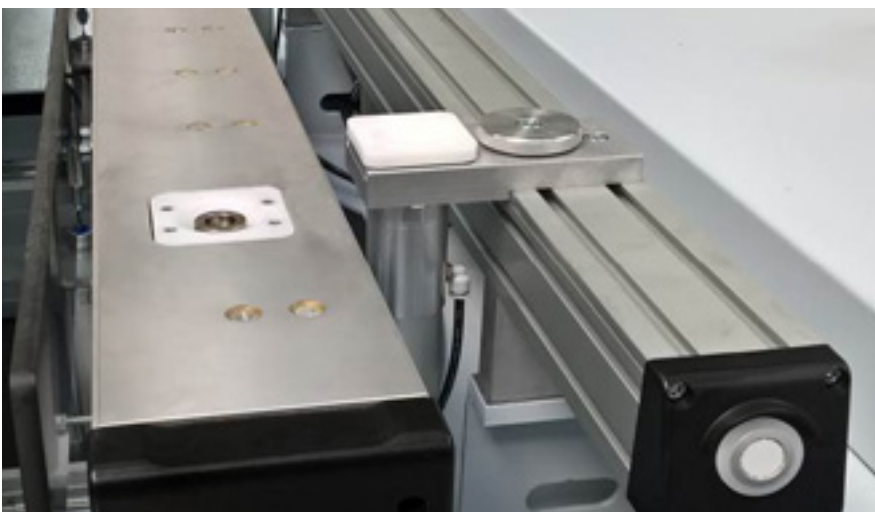

Side stops can be moved via a quickrelease mechanism.



**Linear guide and insertion aid** – easy handling by consoles with highly precise linear guides and robust insertion aids with two pneumatic cylinders. Vacuum and compressed air connections for pneumatic clamps and clamping templates are integrated in the consoles.

## Automatically in the right place: The A-table

The A-table is the key to greater convenience and automation. Through the program-controlled positioning of the consoles and clamping equipment, batch size 1 operation is possible without manual intervention and workpieces can be moved apart after a separating cut.

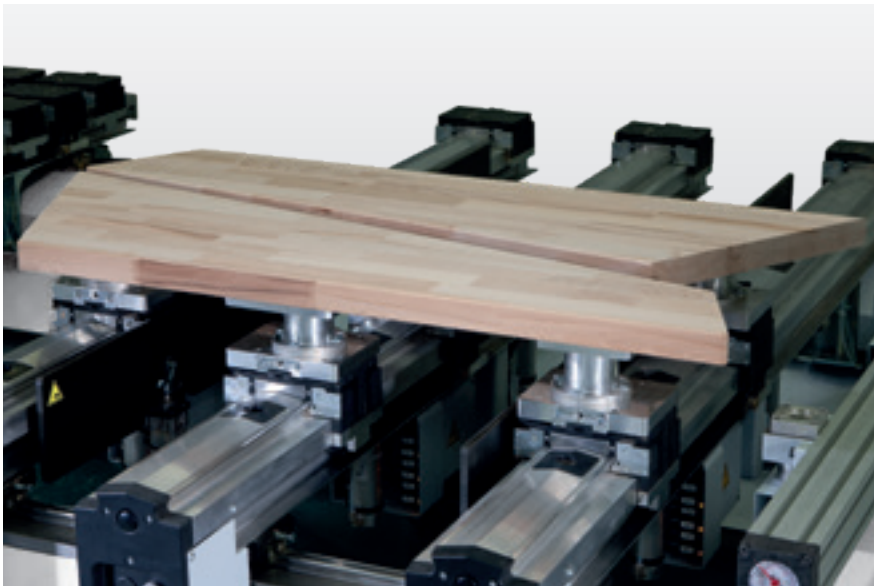

**movePart** ensures automatic moving apart after separation in the program sequence for complete processing.

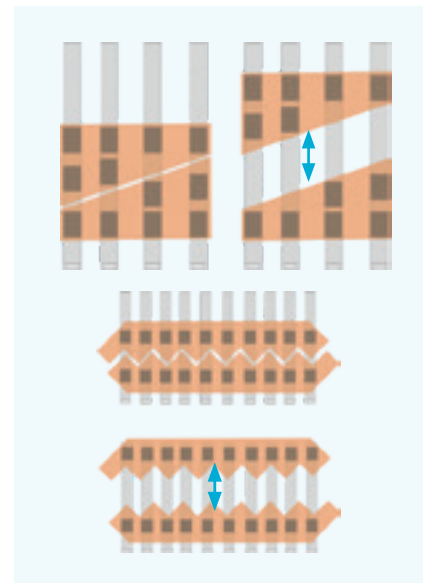

In staircase construction, for example, stages can be moved after separating for complete processing.

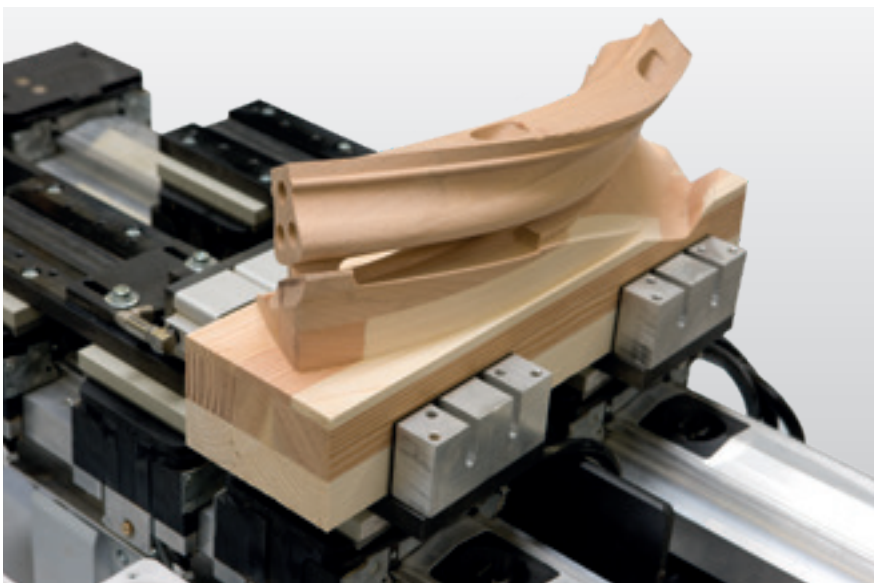

**Clamping unit** ensures secure and quick clamping of jambs and scantling.



## HOMAG software solutions: The basis for simple and efficient operation

Our processing centers are one thing – the software to operate them conveniently and easily day-to-day is another. HOMAG software and control modules ensure maximum flexibility and operational safety. Naturally with HOMAG:

Interfaces to external programming and construction systems, auxiliary programs for nesting and modules for machine monitoring and performance tracking.

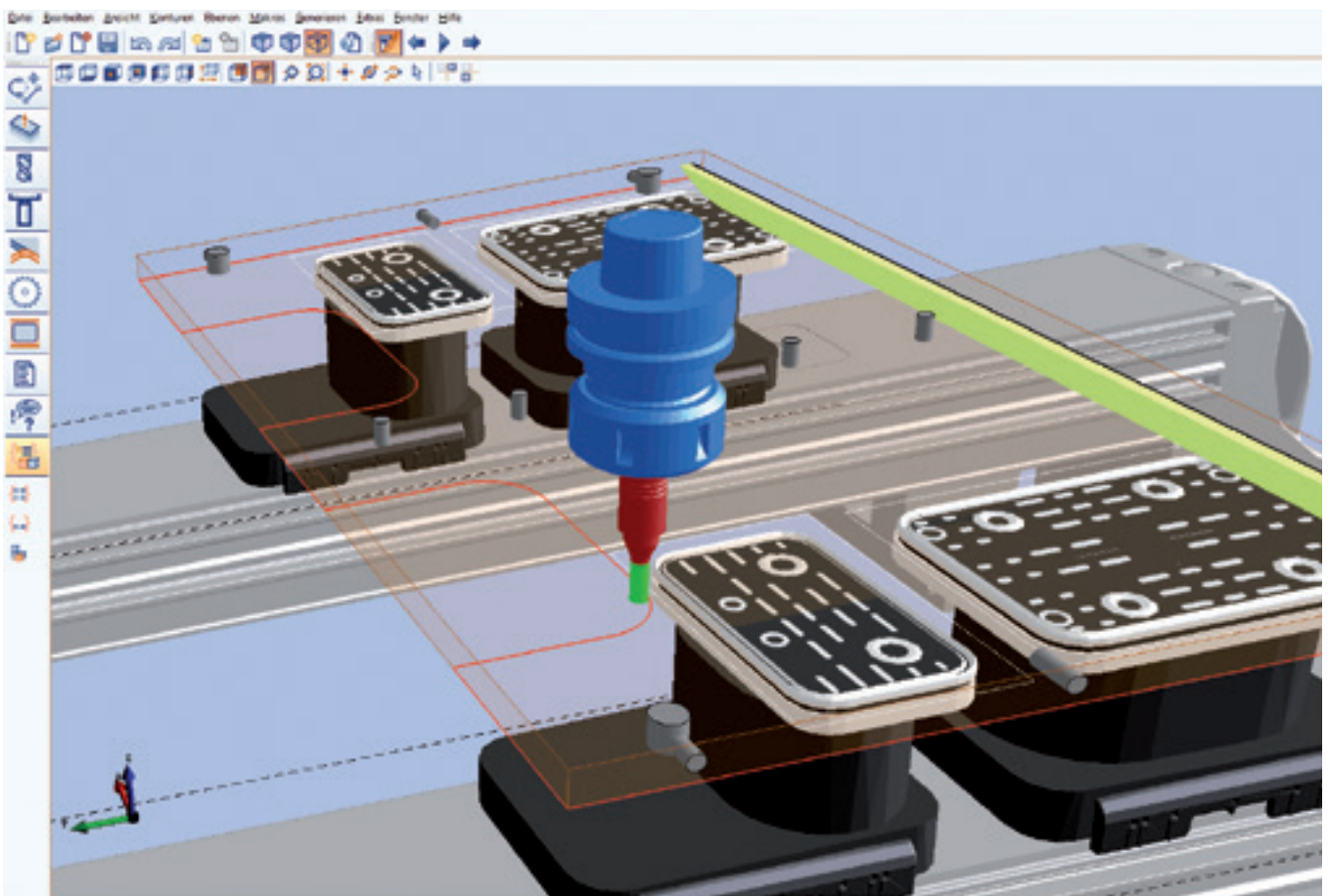

### woodWOP – efficient thanks to fast programming

- Fast and intuitive operation thanks to simple, direct navigation
- Select from a choice of variables for flexible variable programming
- Quickly create individual subprograms
- Increased programming security through 3D images of workpieces, processing and clamping equipment
- Very easy to use through infinitely adjustable windows, multi-screen capability, language-neutral input screens, help images, etc.
- The largest online forum for CNC programming is: [forum.homag.com](http://forum.homag.com)

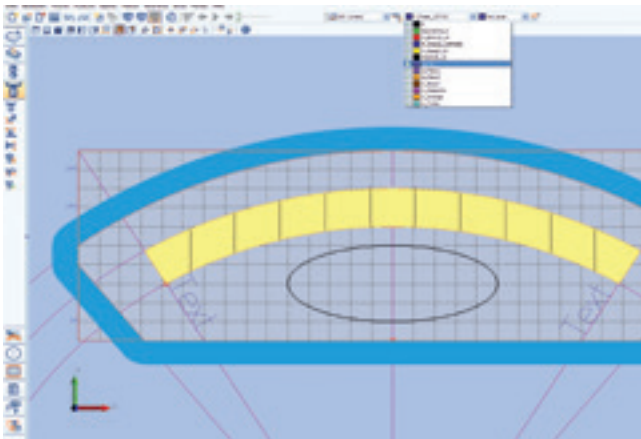

**woodWOP CAD-Plugin**

- CAD functions integrated directly into woodWOP
- Creation of your own CAD drawings on the machine and the work preparation station
- Import of CAD objects in the formats DXF, IGS, STP, STL

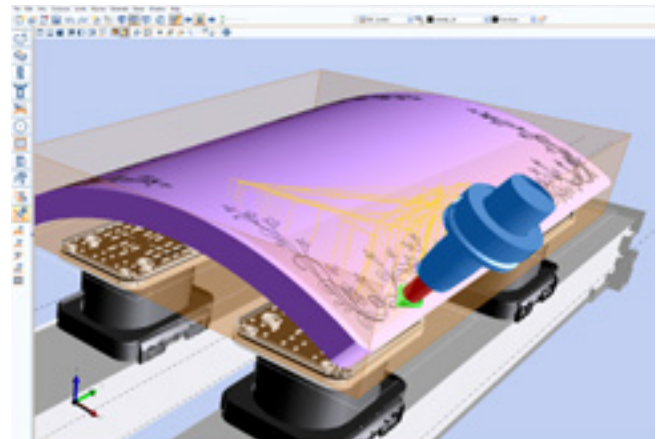

**woodWOP CAM-Plugin**

- CAD/CAM functions directly integrated into woodWOP
- Rapid construction of 3D surfaces in the CAD plugin or by importing 3D models
- Automatic generation of the milling paths for roughing, finishing and formatting 3D objects
- Safe work, because the milling paths and the overrun movements are displayed graphically and simulated in woodWOP

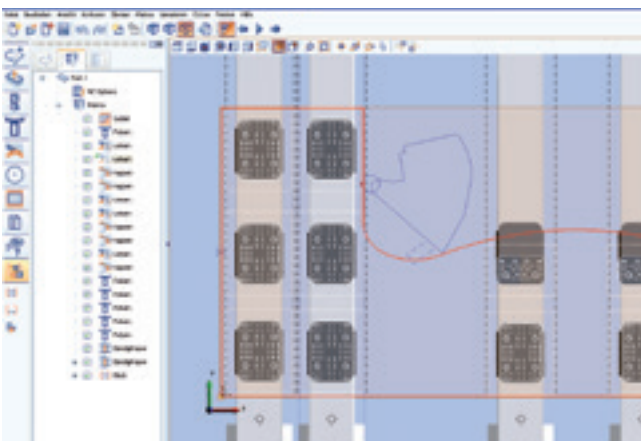

**woodWOP Wizard – automatic for perfect edge**

- Automatic generation of the entire processing sequence for the edging
- Creation of all processing steps such as pre-milling, joint trimming, edging, cutting, flush trimming and scraper
- Considers workpiece geometry, edge overhangs and edge type
- Time savings of over 90% compared to conventional programming

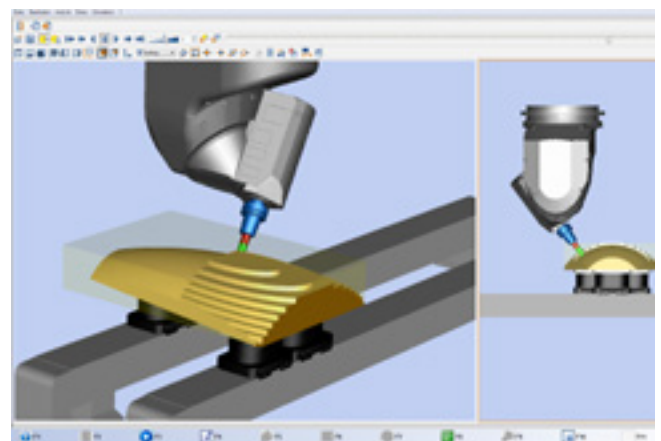

**woodMotion – processing simulation of programs**

- Graphic simulation of the CNC program on the workstation PC
- Optimal program preparation as running-in periods on the machine are reduced
- Simulation of 5-axis processing including material removal
- Display of the actual processing times and collision monitoring between tool and clamping elements



### powerTouch PC87 with full touch operation

- 3D view of the machine bed, consoles, suction unit and workpiece
- Simple assignment using drag & drop
- Saving and loading of complete assignment situations
- Automatic location-specific suction unit recommendation with selectable suction unit types
- Manual clamping equipment positioning using touch under consideration of all travel areas

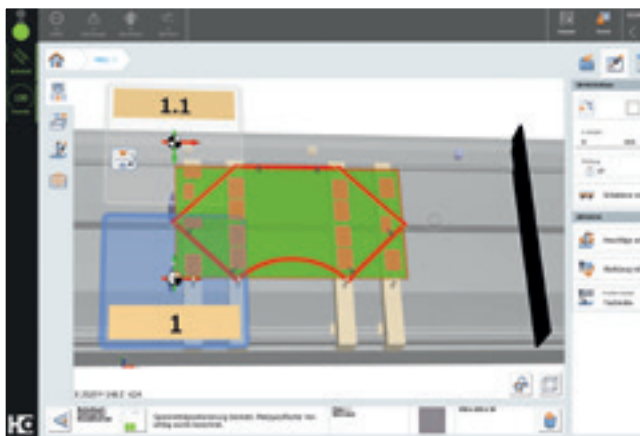

### Slot assignment

- Can be operated completely by touch
- Simple assignment using drag & drop
- Preview of the woodWOP programs as a miniature view
- Assignment of parts with different thicknesses
- Saving and loading of complete assignment situations
- 3D view can be freely rotated
- 3D representation of machine bed, consoles, stop cylinders, suction unit and clamp, workpiece and processing

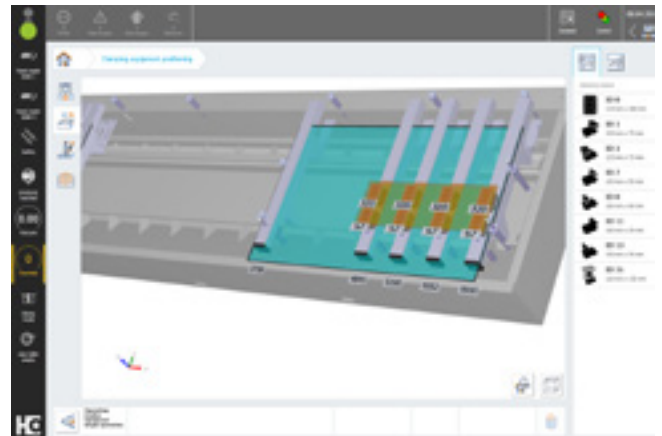

### Automatic suction unit recommendation for workpiece or entire table

- Suction unit recommendation with preselection of suction unit types
- Processing tracks as an aid for positioning clamping equipment
- Manual clamping equipment positioning using touch under consideration of all travel areas
- Check of suction units already included in the woodWOP program
- Warning when suction units are not in the correct position



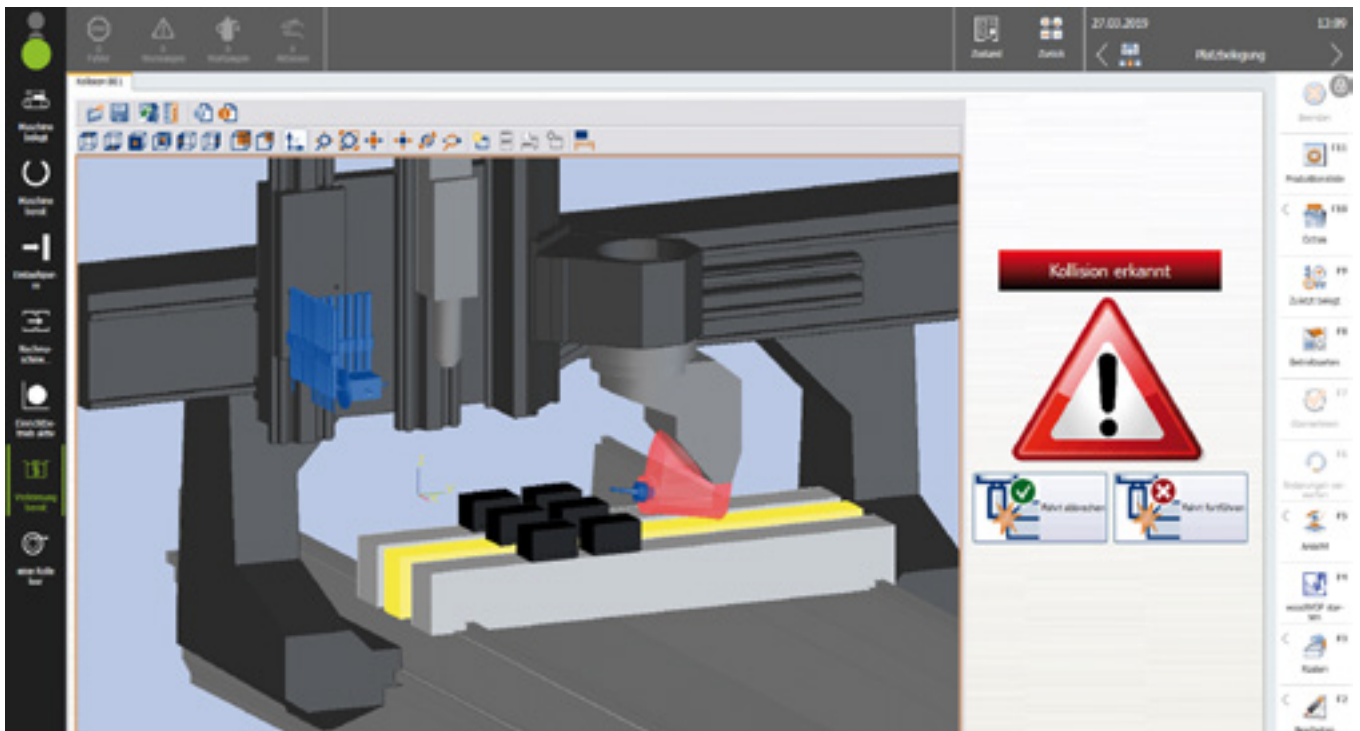

**collisionControl – permanent security for your machine**

- Monitors for potential collisions between machine components and clamping equipment during processing
- The machine stops automatically in the event of an imminent crash situation
- The crash situation is displayed as a snapshot with colored collision bodies
- The machine is displayed as an active 3D model in live mode



**woodScout – help in your language**

- Optional powerful diagnostic system
- Graphic display of the malfunction location on the machine
- Clear plain-text error messages in different languages
- Adaptive system through the allocation of causes and measures



**Graphic tool data base**

- Record quantities and actual operating times on the machine
- 3D representation of the tools and units
- Graphic setup of the tool changer using drag & drop



**Machine data acquisition MMR – for a productive environment**

- Record quantities and actual operating times on the machine
- Integrated maintenance instructions for optimum time and quantity-based planning, as well as performing maintenance
- Optional professional version allows detailed breakdown and logging of the recorded data

## The next generation of powerTouch: **powerTouch2**

Faster, more comfortable, clearer: Enjoy the benefits of our further improved powerTouch user interface. We have optimized our standardized operating concept and further adapted it to our customers' requirements. Controlling your HOMAG machines is now even faster and more intuitive. The new, modern design has a clear structure. The innovative

touch operation allows you to achieve the desired result easily and comfortably.

Our successful powerTouch philosophy – **standardized, simple, ergonomic, evolutionary** – consistently further developed.



### **Clearer structure**

The structure of the powerTouch2 screen is even clearer. You only see the information that is relevant for you. The important points at a glance – but you still have all the details. All in a fresh, attractive design.

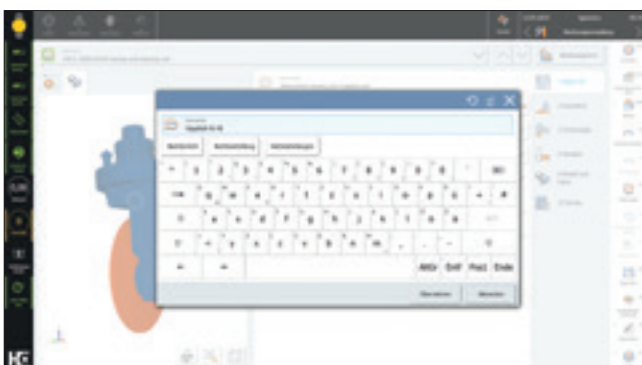

### **Even faster**

With the new powerTouch generation, you can enter information at your machine even more quickly. Compared to the previous version, you can achieve a time saving of up to 30%. This is possible thanks to new features, such as automatic word completion, a pop-up keyboard that can be kept open and Windows-like functions, such as the selection of common actions directly via the start button.

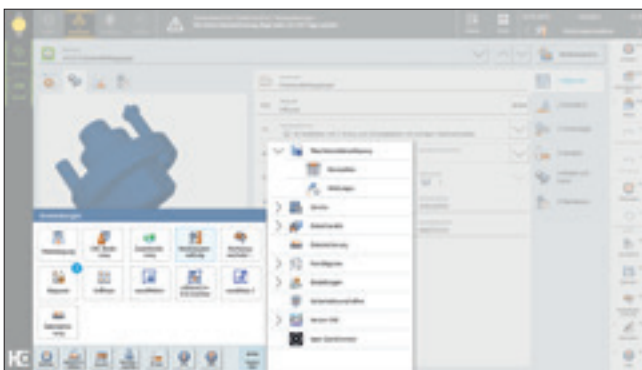
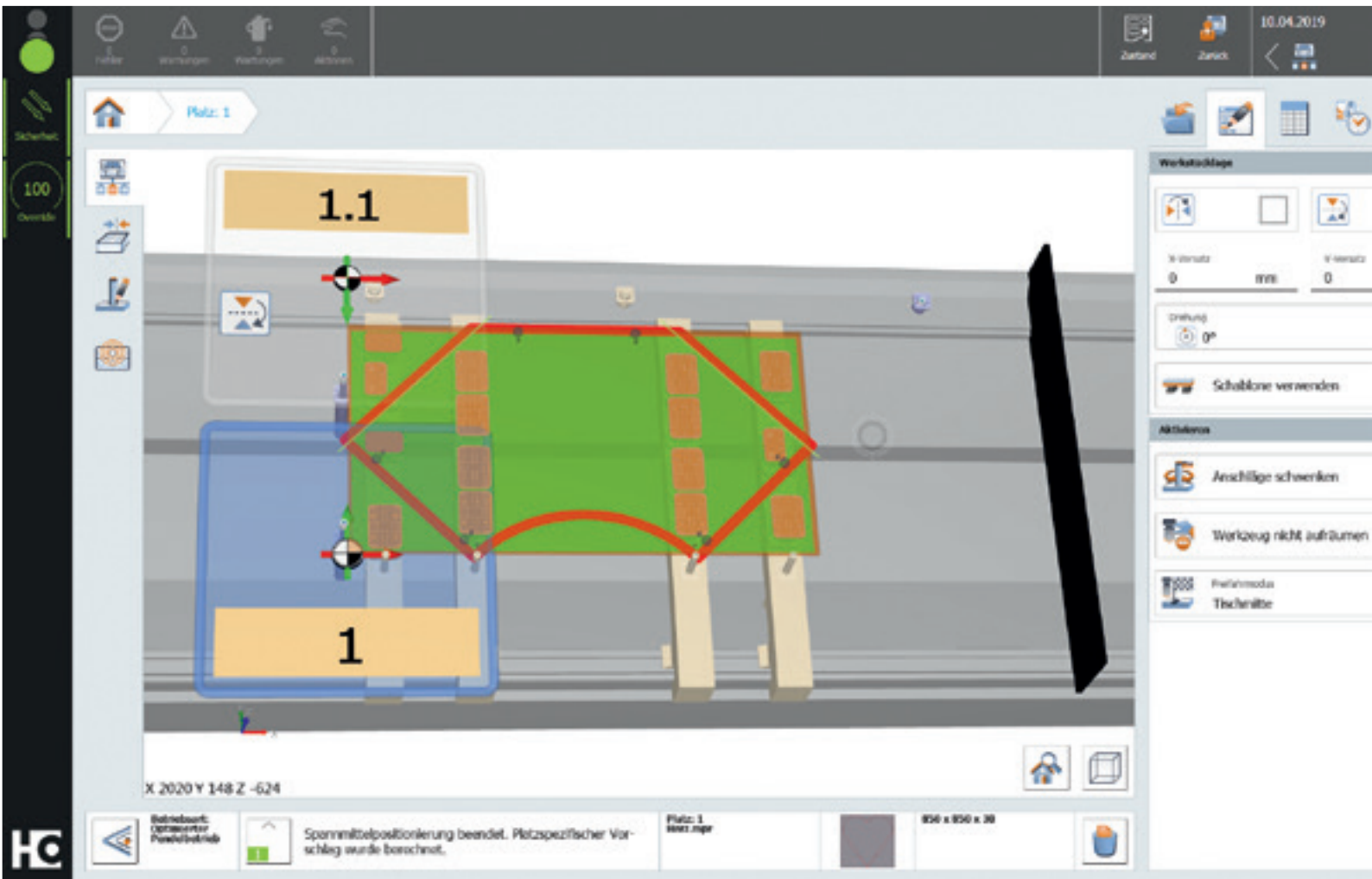

**More comfortable**

We have also improved the traffic light dialog and the „Start“ menu. When you press and hold the program icon, not only are the possible actions displayed, you can also access and activate them directly. Operation is therefore immediate and you do not lose any time opening applications. What’s more, for the applications, illustrations and additional information can be displayed instead of simple program icons. This also provides more transparency and avoids unnecessary navigation into applications.



**More intuitive**

Operating the machine is child’s play. Many of the functions are similar to those of a smartphone or tablet and will therefore be familiar to you. Even beginners will feel immediately at ease and will soon be able to control the machine comfortably.

# Easy to get. And easy to use.

## tapio is the open wood industry ecosystem

This means that everyone involved in the wood industry can participate.  
Because together with our business partners, we develop digital solutions for everyone.



### Just have a try:

Free use of the MachineBoard app! Just register under tapio and “connect” the machine [www.tapio.one](http://www.tapio.one). The complimentary usage is limited in time.

# Apps that make working life easier.

# tapio

Partner

## DataSave

- Protects machine and configuration expertise
- Faster service for machine breakdowns
- Saves time when restarting production
- Saves on maintenance costs
- Automatic backups of several machines

## ServiceBoard

- Create service cases quickly and easily and send them to the correct service partner
- Live video diagnostics to solve service cases with image support
- Video reduces the language and distance barriers
- Also works without a machine connection to tapio (and is therefore ideal for older machines)

## MachineBoard

- Push notifications
- Machine data and status can be viewed from anywhere in real time
- Lists of errors, warnings, maintenance tasks and actions
- Displays the remaining time until the next intervention by the machine operator



**Free demo for all tapio apps, no registration required. Simply download and test.**

Currently available in the EU and Switzerland

(Due to the fast pace of the IT-landscape, the compatibility to the tapio platform is warranted for five years.)

# HC LIFE CYCLE SERVICES

The sale of our machines comes with all-in optimum service backup and individual advice. We support you with service innovations and products which are especially tailored to your requirements. With short response times and fast

customer solutions we guarantee consistently high availability and economical production – over the entire life cycle of your machine.



## REMOTE SERVICE

- Hotline support via remote diagnosis by our trained experts regarding control, mechanics and process technology. Thus, more than 90% less on-site service required and consequently a faster solution for you!
- The ServiceBoard App helps to solve tasks in a fast, simple and concrete way. This is achieved by mobile live video diagnosis, automatic sending of service requests or the online spare parts catalog eParts.



## SPARE PARTS SERVICE

- High spare parts availability and fast delivery.
- Ensuring quality by predefined spare parts and wear parts kits, comprising original spare parts.
- Identify and inquire for spare parts online under [www.eParts.de](http://www.eParts.de) 24/7, or buy even faster and more comfortably in the new HOMAG Webshop eCommerce.



## MODERNIZATION

- Keep your machinery up to date and increase your productivity as well as your product quality, This is how you can meet tomorrow's requirements today!
- We support you with upgrades, modernization as well as individual consultancy and developments.



## DIGITAL SERVICES

- ISN (intelliServiceNet) – The new remote service solution of the future! Fast restart of production because the remote service employee has extensive access to relevant physical data.
- intelliAdvice App – provides help for self-help. The preventive solutions proposed in the new App are the combination of our experiences and existing machine data.



## SOFTWARE

- Telephone support and consultancy through software support.
- Digitalization of your spare parts via 3D scanning saves time and money compared to new programming.
- Subsequent networking of your machinery with intelligent software solutions ranging from construction to production.



## FIELD SERVICE

- Increased machine availability and product quality by certified service staff.
- Regular checks through maintenance / inspection guarantee the highest quality of your products.
- We offer you the highest availability of technicians in order to reduce downtimes in case of unpredictable troubles.

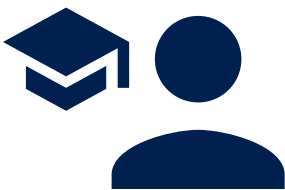

**TRAINING**

- Thanks to training perfectly suited to your requirements, your machine operators can optimally operate and maintain the HOMAG machines.
- The training also include customer-specific training documents with exercises proven in practice.
- Online training and webinars. Learn without traveling, meet your trainer in the digital classroom.

For you more than...

**1,350**

service employees worldwide

**90 %**

less on-site service thanks to successful remote diagnosis

**5,000**



customer training sessions per / year

**150,000**

machines, all electronically documented in 28 different languages – in eParts

# Overview | Configurations

The choice is yours. Here is a package available for all common requirements. Nothing is left to be desired.

		Spindle			C-axis	
						
						Piggybacking in X
4-axis	Basic	Air-cooled 10 kW / 13.2 kW	Liquid-cooled 12/15/18.5 kW		✓	✓
	Future				✓	✓
	Performance				✓	
5-axis	Basic	<b>DRIVE5C</b>	<b>DRIVE5C</b>	<b>DRIVE5C+</b>		✓
	Future	Liquid-cooled 10 kW	Liquid-cooled 12 kW	Liquid-cooled 15 kW		✓
	Performance					
	Solid					

**Basic**

Universal basic configuration for furniture parts, components and edge gluing.

**Future**

Increased performance in panel processing thanks to more drilling spindles.

**Performance**





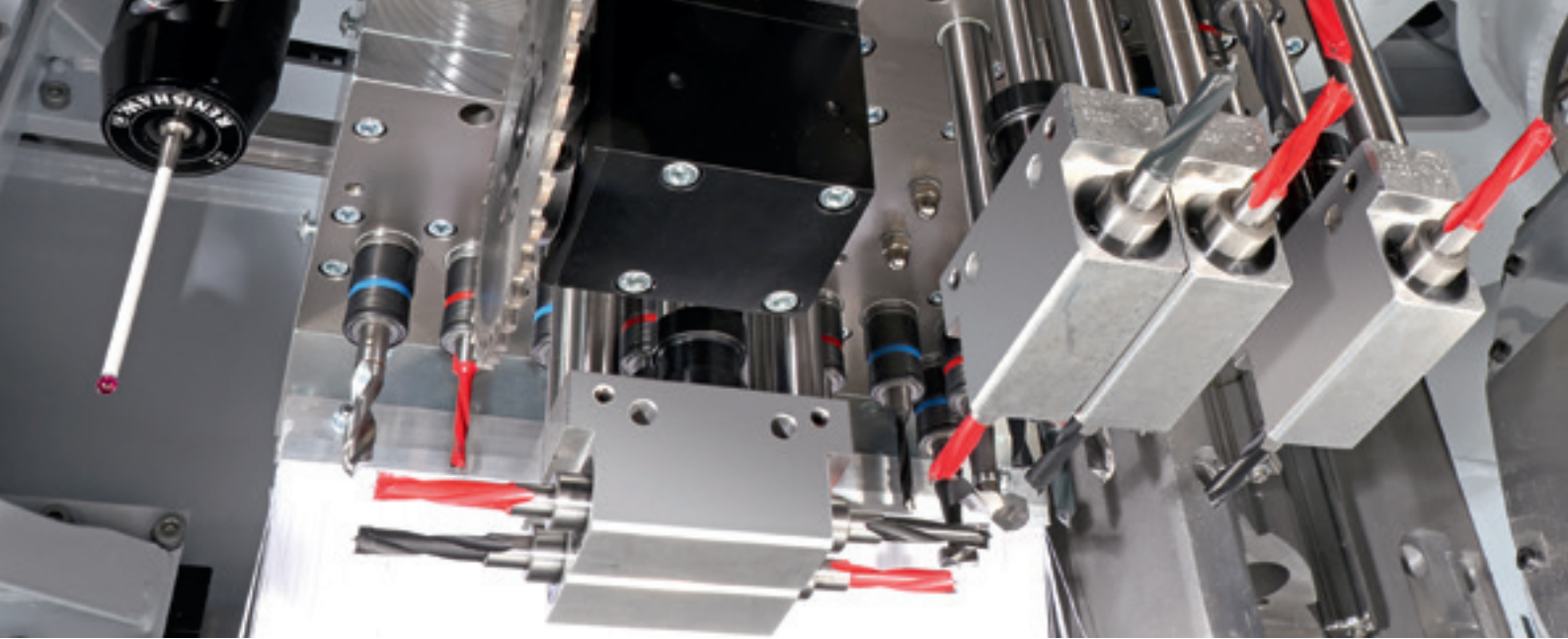

Fast drilling and universal application with high tool variation.

**Solid**

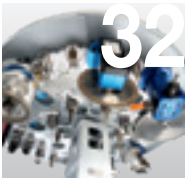
Powerful routing spindle and large changer. Ideal for window, stairs and door manufacturing.





Tool changer			Drilling gear				
Disk changer		Linear changer	Drilling [7500 High-Speed]			Grooving	
Piggybacking in X	Piggybacking in Y		vertical	horizontal in X	horizontal in Y	Attachments	S0/90°
 32	 10	 8					
○	○	✓	12	4	2	○	✓
○	○	✓	21	6	4	○	✓
✓	○	✓	21	6	4	○	✓
○	○	✓	12	4	2	○	✓
○	○	✓	21	6	4	○	✓
✓	○	✓	21	6	4	○	✓
✓	○	✓	12	4	2	○	✓

Standard: ✓

Option: ○

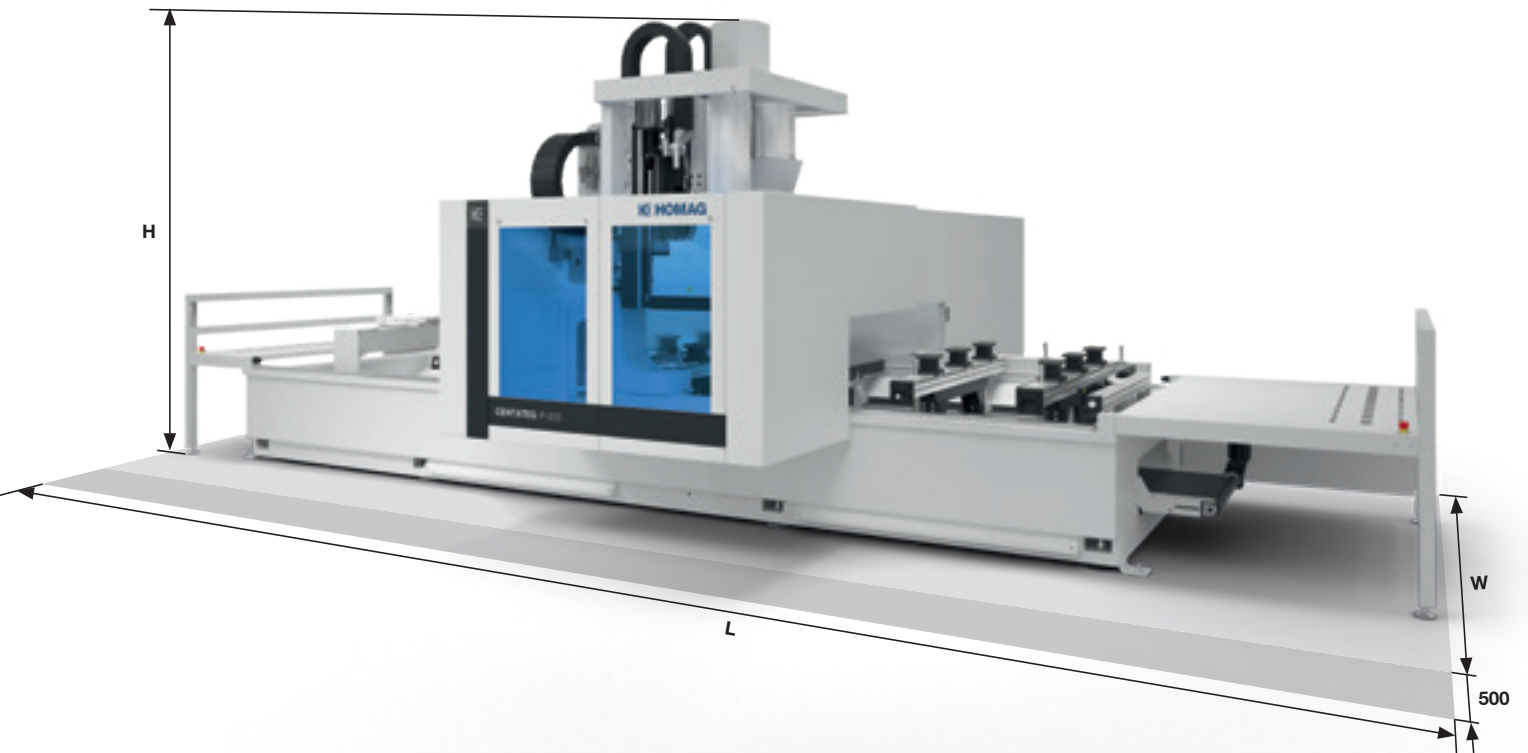

**WORKING DIMENSIONS**

Y = Workpiece width [mm/inch]	CENTATEQ P-310			CENTATEQ E-310	
	A = 0° with tool diameter 25 mm	A = 90° with tool length 230 mm / with all aggregates	A = 90° / with all aggregates	Edge gluing and post-processing	
	Rear stop	Rear stop	Front stop	Rear stop	Front stop
/16	1,600 / 63.0	1,350 / 53.1	1,350 / 53.1	1,570 / 61.8	1,350 / 53.1
/19	1,900 / 74.8	1,750 / 68.9	1,750 / 68.9	1,900 / 74.8	1,750 / 68.9

X = Workpiece length [mm/inch]	A = 90° with tool length 140 mm/with all aggregates	
	Individual processing	Alternating processing*
	/33	3,300 / 129.9
/42	4,200 / 165.4	1,450 / 57.1
/60	6,000 / 236.2	2,350 / 92.5

Z = Workpiece thickness [mm/inch]	from console	with clamping device H = 100 mm
	300 / 11,8	200 / 7,9

**INSTALLATION DIMENSIONS**

Machine type	Installation length [mm/inch]			Installation depth [mm/inch] with 32-fold tool changer		Installation height [mm/inch]
	L			W		H
	/33	/42	/60	/16	/19	
<b>CENTATEQ P-310</b>	7,400 / 291.3	8,300 / 326.8	10,100 / 397.6	5,045 / 198.6	5,345 / 210.4	2,910 / 114.6
<b>CENTATEQ E-310</b>	7,400 / 291.3	8,300 / 326.8	10,100 / 397.6	5,545 / 218.3	5,845 / 230.1	2,910 / 114.6

\* Dimension with central division.

Technical data and photographs are not binding in every detail. We reserve the right to make changes in the course of further development.

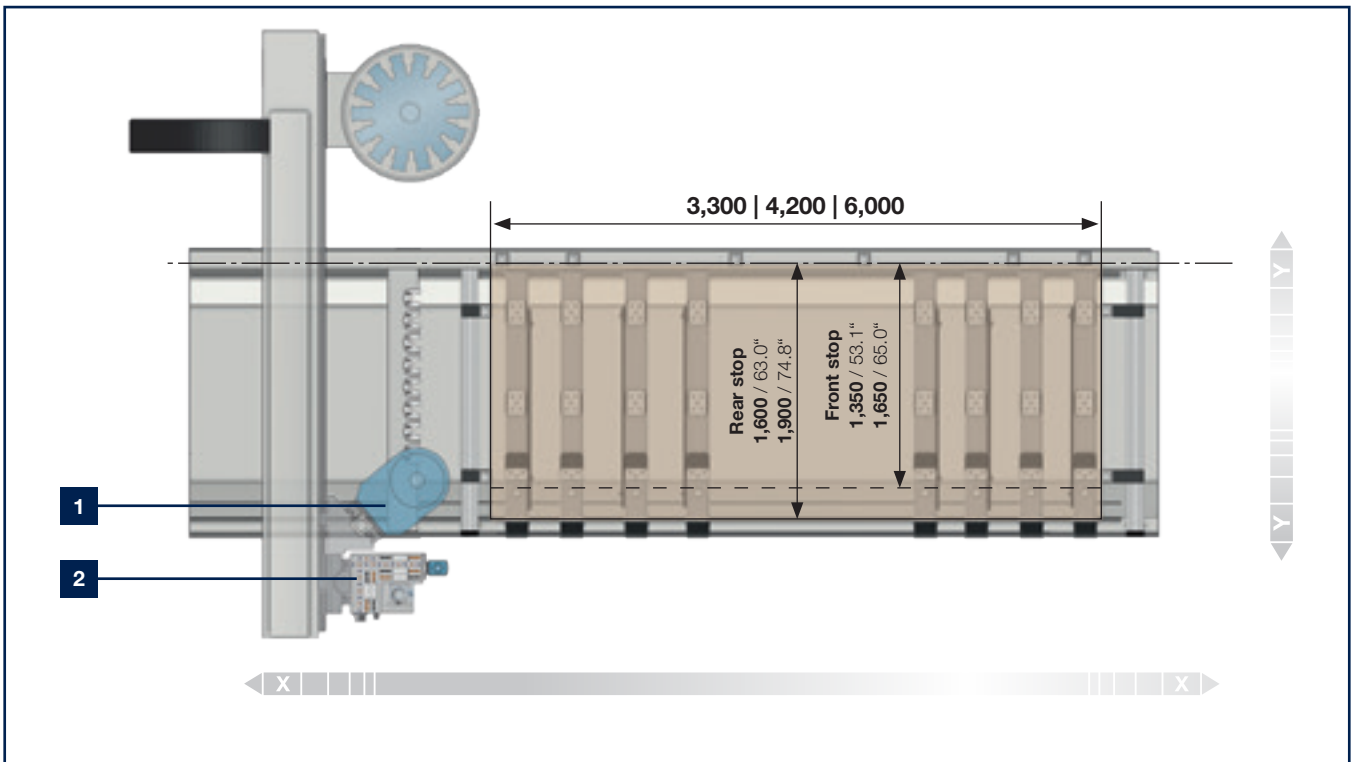
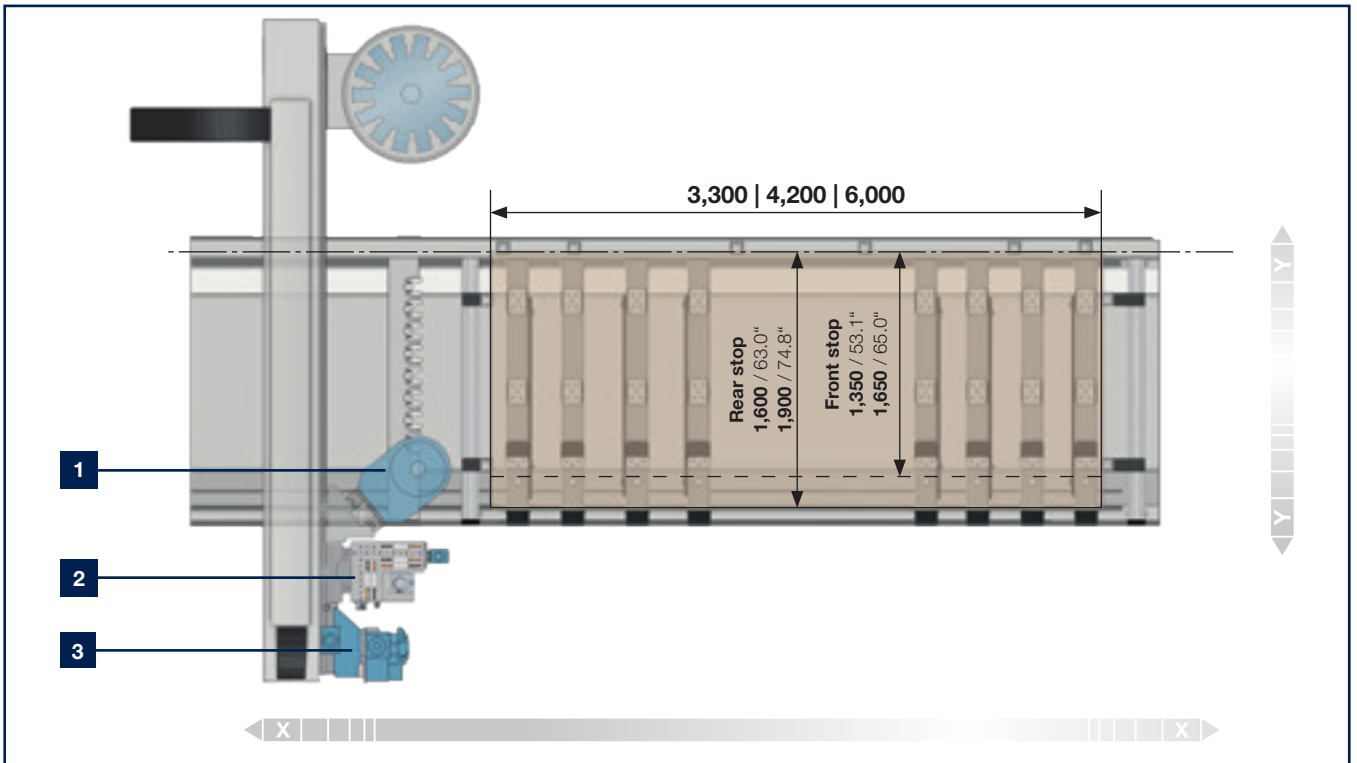

- 1 Routing spindle
- 2 Drilling gear
- 3 Edge banding unit

mm / inch

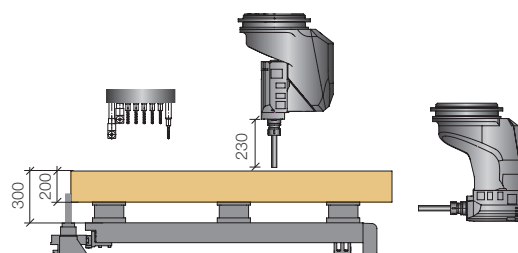

## **HOMAG Group AG**

info@homag.com

www.homag.com



## **YOUR SOLUTION**